

# ZEP2 - 360LF2 NDW

360 - LED 300 W



- **Type:** Single lens luminaire
- **Source:** LED 300 W
- **Optics:** 200 mm Fresnel lens
- **Colour temperature:** Neutral Daylight White

Single lens

## Low running costs, high performance

Equipped with an enhanced white LED source providing a higher output with a significant efficiency, this 200 mm Fresnel lens presents an exceptional flat and variable beam angle with very wide opening, combined with an electronic flicker-free dimmable PSU to create a powerful yet economical LED washlight. Perfect for TV studio, theatre, event and architectural applications.

### Features

- **Theatre front cassette:** no light spill to distract audiences or performers
- **Colour runners:** double runners to hold accessories and colour filters
- **Barn door:** unique rotating barn door with 4 individually rotating blades – makes even the most difficult angle possible
- **Remote setup:** all parameters can be adjusted by RDM protocol
- **Adjustable response time:** choice of fast or slow dimming for tungsten-like simulation
- **DMX:** 8 or 16 bit dimming and strobe function
- **Local setup:** DMX address and mode, dimming curve and response time through 4-button display with automatic light switch-off
- **Control:** local, DMX, wireless DMX (option)
- **Focus reference:** index for easy focus reference
- **Focus adjustment:** smooth focus adjustment from rear
- **Tilt reference on hanging yoke:** index for rapid re-positioning

### Optical

- **Unique 200 mm (8 in) lens:** no equivalent on the market in terms of light output and beam quality
- **Wide angle:** up to 90° from edge to edge
- **Beam shaping:** efficient barndoors in any focus position
- **Electronic dimmer:** dimming without clipping or cut-out at low intensity levels; high quality smoothing
- **No colour shift:** colour temperature remains the same when dimming

### Construction

- **Made in France:** fully manufactured in Robert Juliat premises retaining complete control over all aspects of quality
- **PSU:** built-in electronic flicker-free power supply for easy, plug-and-play installation
- **Power connectors:** neutriK® powerCON TRUE1 TOP IN and OUT connectors for daisy chaining
- **Silent-running cooling fans:** ideal for TV studios and opera houses
- **Electronic thermal management system:** ensures maximum performance of the system without any risk of overheating
- **Bodywork:** strong sheet metal construction for durability
- **Captive knobs and handles:** additional security when working at height or in transit
- **Safety first:** front accessories safety cable attachment point

Picture:360LF + CF1000

DSEN309\_360LF2\_NDW - 23/03/2022

Robert Juliat reserves the right to change or alter any of the items detailed on this page, to increase or improve manufacturing techniques without prior notice.

Robert Juliat S.A.S., 32 rue de Beaumont, 60530 Fresnoy-en-Thelle - France  
Telephone : +33 (0)3 44 26 51 89 - fax : +33 (0)3 44 26 90 79 - info@robertjuliat.fr  
www.robertjuliat.com



ROBERT JULIAT

## Source

- **Lamp type:** LED
- **Power:** 247 W

LED specifications	Power *	Lumen output*	Colour temperature*	Life*	CRI* (min)
SUHD60 V3 NDW (RJ / Osram)	247 W	24 150 lm	5000K	100 000 h	92

Life data following L70B50 standard - (\*) manufacturer's data

## Optics

### Characteristics

- **Type:** Single lens
- **Beam range:** 12° to 64°
- **Lens:** 200 mm Fresnel lens

### Gel filter

- **Shape:** Square
- **Standard size:** 215x215 mm (8.5x8.5 in)

## Photometrics

with SUHD60 V3 NDW (RJ / Osram) source

### • Optics @ 12°

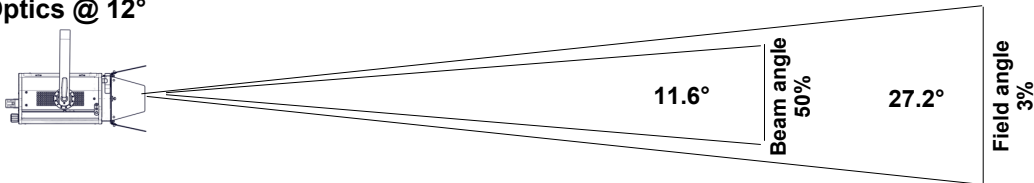

**Beam intensity**  
155 700 cd

<b>Distance</b>	3 m	5 m	7 m	10 m	12 m	15 m	
<b>Diameter</b>	1.5 m	2.4 m	3.4 m	4.8 m	5.8 m	7.3 m	
<b>Illumination</b>	17 500 lux	6 300 lux	3 200 lux	1 600 lux	1 100 lux	700 lux	
<b>Distance</b>	10 ft	15 ft	25 ft	35 ft	40 ft	50 ft	<b>CCT</b>
<b>Diameter</b>	4.8 ft	7.3 ft	12.1 ft	16.9 ft	19.4 ft	24.2 ft	5 400 K
<b>Illumination</b>	1 600 fc	700 fc	250 fc	130 fc	100 fc	65 fc	<b>CRI</b>
							93

### • Optics @ 64°

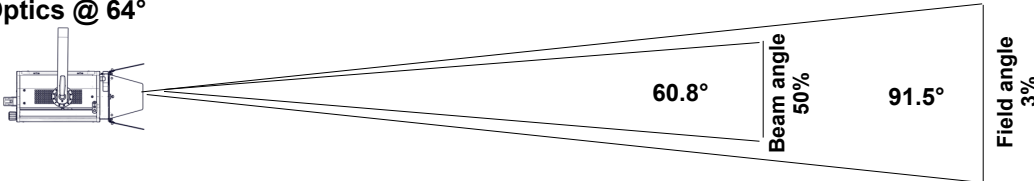

**Beam intensity**  
13 500 cd

<b>Distance</b>	3 m	5 m	7 m	10 m	12 m	15 m	
<b>Diameter</b>	6.2 m	10.3 m	14.4 m	20.5 m	24.6 m	30.8 m	
<b>Illumination</b>	1 550 lux	550 lux	280 lux	140 lux	95 lux	65 lux	
<b>Distance</b>	10 ft	15 ft	25 ft	35 ft	40 ft	50 ft	<b>CCT</b>
<b>Diameter</b>	20.5 ft	30.8 ft	51.3 ft	71.9 ft	82.1 ft	102.7 ft	5 330 K
<b>Illumination</b>	140 fc	65 fc	22 fc	12 fc	9 fc	6 fc	

## Remote control

- **Data protocol:** USITT DMX512-A  
RDM

- **Data IN connector:** 5 pins XLR male
- **Data OUT connector:** 5 pins XLR female



### • DMX chart:

#### Mode 1 (1 channels)

Dimmer

#### Mode 2 (4 channels)

Dimmer  
Dimmer fine  
-  
Strobe

#### Mode 3 (5 channels)

Dimmer  
Dimmer fine  
-  
Strobe  
Dimmer master

## Dimensions and weight

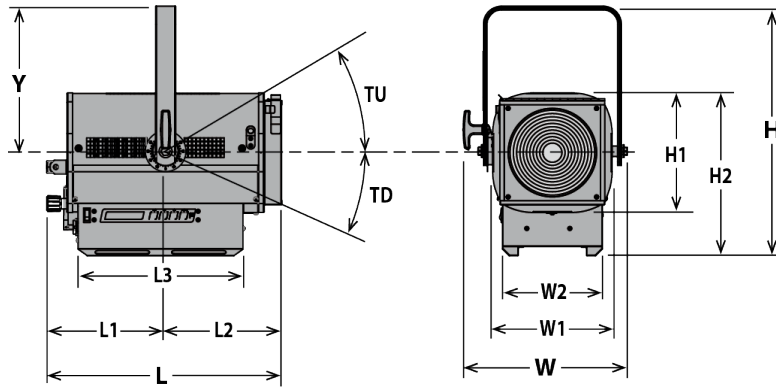

**Weight:** 15.2 kg (33.4 lbs)

Height	Length	Width	Yoke	Tilt
H= 520 mm (20.5 in)	L= 494 mm (19.4 in)	W= 344 mm (13.5 in)	Y= 303 mm (11.9 in)	TU= 90°
H1= 250 mm (9.8 in)	L1= 250 mm (9.8 in)	W1= 250 mm (9.8 in)		TD= 90°
H2= 342 mm (13.5 in)	L2= 244 mm (9.6 in)	W2= 210 mm (8.3 in)		
	L3= 346 mm (13.6 in)			

## Shipping

- **Weight :** 18.2 kg (40 lbs)
- **Volume :** .09 m<sup>3</sup> (3.18 ft<sup>3</sup>)

## Installation

- **Minimum distance to illuminated surface:** 0.2 m ( 0.5 ft )
- **Operating position:**

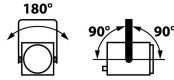

## Construction

- **Housing:** Steel sheet - Aluminium
- **Colour:** Black
- **Cooling:** Low noise variable fan
- **Maximum ambient temperature (Ta):** 40°C (104°F)
- **Maximum case temperature (Tc):** 70°C (158°F)
- **Total heat dissipation:** 976 BTU/h
- **Ingress Protection (IP) rating:** IP20

## Electrical compatibility

- 220/230 V - 50 Hz
- 220/230 V - 60 Hz
- 245 V - 50 Hz
- 100 V - 50 Hz
- 110/120 V - 60 Hz
- 100 V - 60 Hz
- 208 V - 60 Hz
- Selector: automatic detection

## Power input



- **Type:** removable power cord with Neutrik powerCON TRUE1 TOP connector (included)
- **Cable:** H07RNF 3G1.5
- **Length:** 3 m (9.8 ft)
- **Power connector:** CEE 7/7 (2P+E NF/Schuko)

## Power consumption

Voltage	Frequency	Current	Power	Power factor
230 V	50 Hz	1.3 A	286 W	0.97
120 V	60 Hz	2.5 A	291 W	0.99
100 V	60 Hz	3 A	295 W	0.99

## Power Supply Unit

- **PSU:** Internal - Electronic PSU - Flicker free with PFC
- **Control:** Local / DMX
- **Protection:** Mains: 4A 1P1D breaker - UL /
- **Power thru:** Neutrik powerCON TRUE1 TOP - Maximum of 10 units (230 V) / 5 units (120 V)

## Warranty

- **Fixture: 3 years - Source: 5 years**  
See General Sales Condition on website

## Approvals





## Acoustics

- **Noise level:** < 24,9 dB(A)







## Model

<b>360LF2 NDW</b>	LED 300 W Single lens luminaire - 200mm Fresnel - 360LF2 NDW ZEP2 - Neutral Daylight White
-------------------	--

## Options

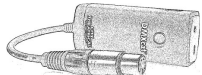
<b>PCP1716A</b>	16A blue 2P+E 6h IEC60309 power connector	
<b>PO/Z</b>	Pole operation yoke (PAN/TILT/Focus)	
<b>W-DMX/ZF2</b>	W-DMX wireless DMX	

## Accessories

<b>PF1000M2</b>	215x215mm metal filter holder <b>1 included</b>	
<b>CF1000</b>	4 rotating leaves on a rotating barndoor - 215x215mm ( without safety cable) - Poids: 1.03 Kg	
<b>DMXcat</b>	Bluetooth DMX/RDM Multifunction test tool - City Theatrical DMXcat®	
<b>876</b>	Hook clamp 40x10mm with 28mm M10 screw for Ø35 to 50mm pipes - SWL: 50Kg - Poids: 1.25 Kg	
<b>880</b>	Hook clamp 40x10mm with 28mm M10 screw for Ø50 to 63mm pipes - SWL: 50Kg - Poids: 1.36 Kg	
<b>CS2</b>	Safety cable Ø3 mm L= 600mm - SWL: 75 Kg	
<b>CS5</b>	Safety cable Ø1,5 mm L=300mm for front accessory with karabiner and quick link - SWL: 25 Kg	