

INSTRUCTION MANUAL

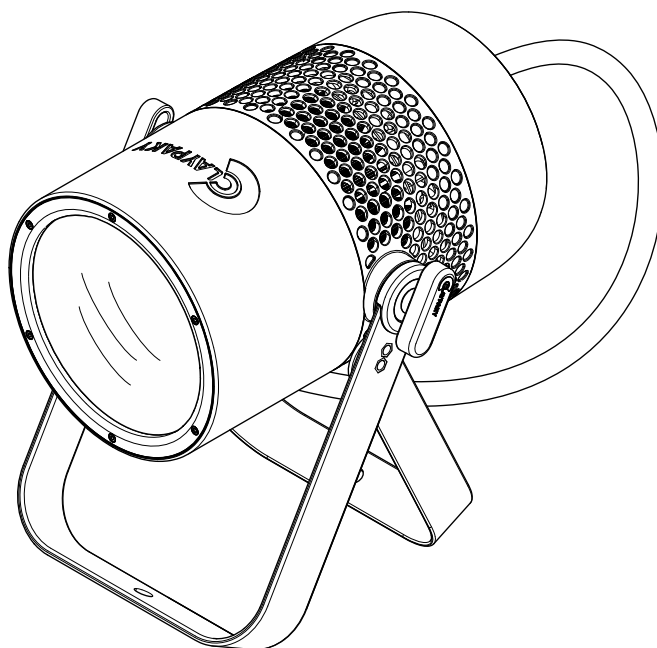

INDEX

Page	Contents
2	1. Safety information
3	2. Unpacking and preparation
3	3. Installation and start-up
3	3.1 Installing the fixture
4	3.2 Connecting to mains supply
5	3.3 Connecting the control signal line: DMX / Art-Net
5	3.4 Switching on the fixture and basic SetUp
7	4. Maintenance
7	4.1 Maintenance and Caution
8	4.2 Battery removal
9	4.3 Opening the covers
10	5. Dimensions
10	6. Cause and solution of problems

Congratulations on choosing a Claypaky product!

We thank you for your custom.

Please note that this product, as all the others in the rich Claypaky range, has been designed and made with total quality to ensure excellent performance and best meet your expectations and requirements.

1. SAFETY INFORMATION

EN

SAFETY INFORMATION

IMPORTANT: Claypaky recommends you carefully read and keep the safety information on this product, also available in digital format at the following link:

www.claypaky.com

Ref: [FIS020 - Safety information Mini-B ParLED Aqua]

IT

INFORMAZIONI DI SICUREZZA

IMPORTANTE: Claypaky raccomanda di leggere accuratamente e conservare le informazioni di sicurezza relative a questo prodotto, sempre reperibili in versione digitale al seguente link:

www.claypaky.com

Rif: [FIS020 - Safety information Mini-B ParLED Aqua]

DE

INFORMATIONEN ZUR SICHERHEIT

WICHTIG: Claypaky empfiehlt, die Sicherheitsinformationen bezüglich dieses Produkts genau zu lesen und aufzubewahren. Sie sind in Digitalversion immer unter folgendem Link auffindbar:

www.claypaky.com

Ref: [FIS020 - Safety information Mini-B ParLED Aqua]

ES

INFORMACIONES DE SEGURIDAD

IMPORTANTE: Claypaky recomienda leer detenidamente y conservar la información de seguridad relativa a este producto. Además, está disponible una versión digital de la misma en el siguiente enlace:

www.claypaky.com

Ref: [FIS020 - Safety information Mini-B ParLED Aqua]

FR

CONSIGNES DE SÉCURITÉ

IMPORTANT: Claypaky recommande de lire attentivement et de conserver les informations de sécurité relatives à ce produit, disponibles en version digitale au lien suivant:

www.claypaky.com

Réf. : [FIS020 - Safety information Mini-B ParLED Aqua]

RU

ИНСТРУКЦИЮ ПО ТЕХНИКЕ БЕЗОПАСНОСТИ

ВАЖНО: Claypaky рекомендует внимательно прочитать и сохранить инструкцию по технике безопасности данного изделия, которая всегда доступна в электронном формате по следующей ссылке:

www.claypaky.com

Наименование: [FIS020 - Safety information Mini-B ParLED Aqua]

2. UNPACKING AND PREPARATION

1



Packing contents - Fig. 1

3. INSTALLATION AND START-UP

3.1 Installing the fixture

2

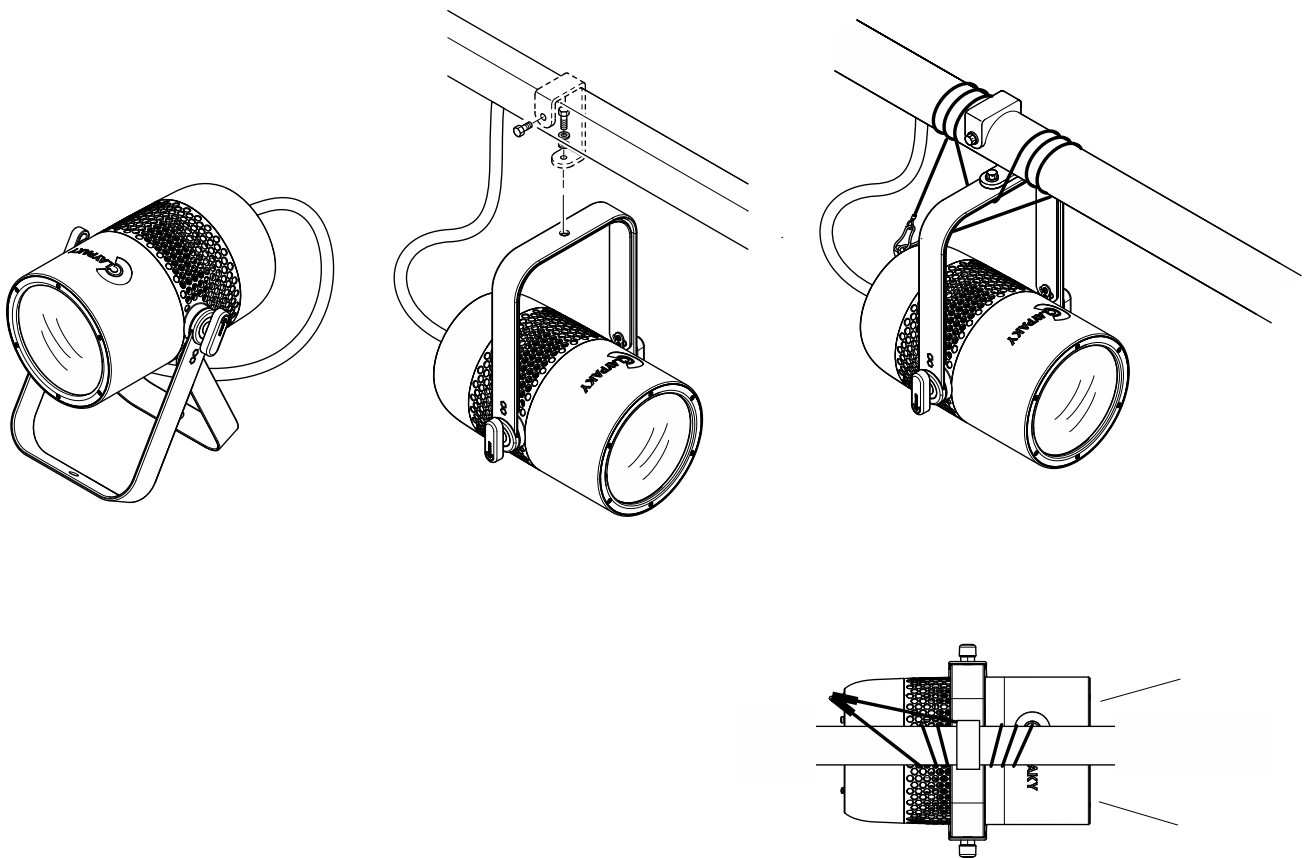

Installing the projector - Fig. 2

The projector can be installed on the floor on a truss or on the ceiling or wall.

WARNING: with the exception of when the projector is positioned on the floor, the safety cable must be fitted. (Cod. 105041/001 available on request). This must be securely fixed to the support structure of the projector and then connected to the fixing point.

3.2 Connecting to mains supply

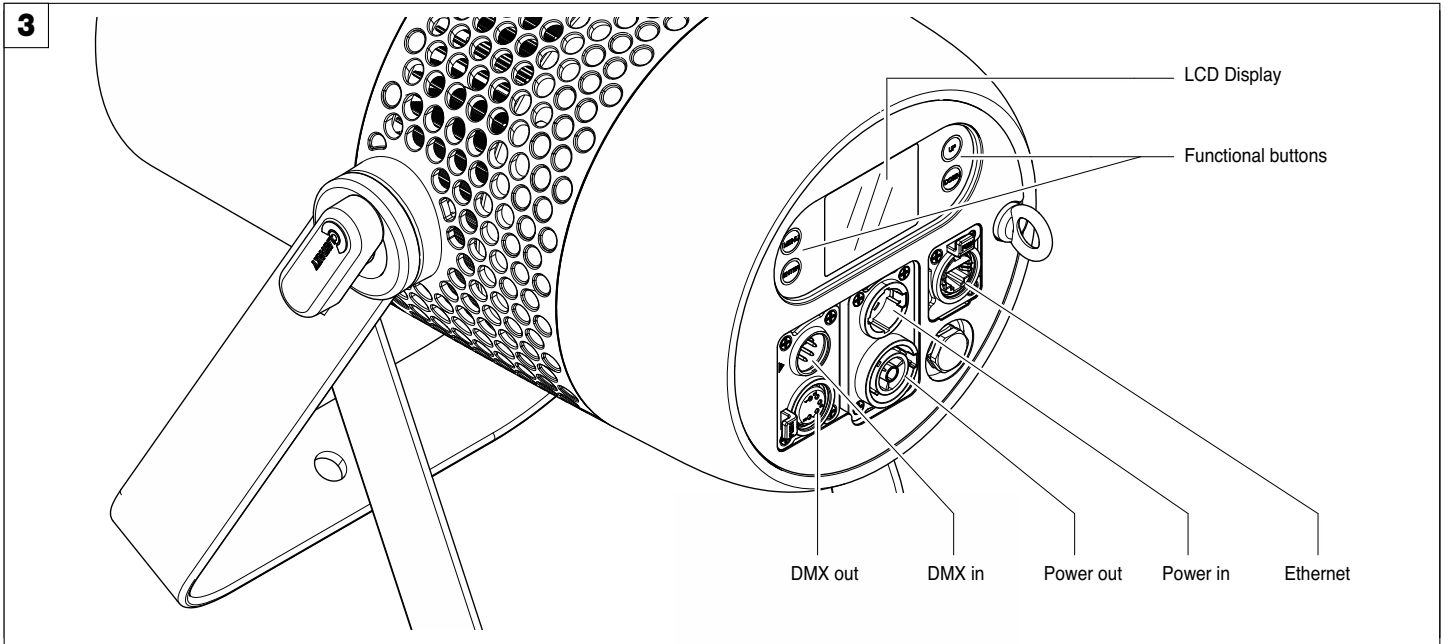

Control Panel - Fig. 3

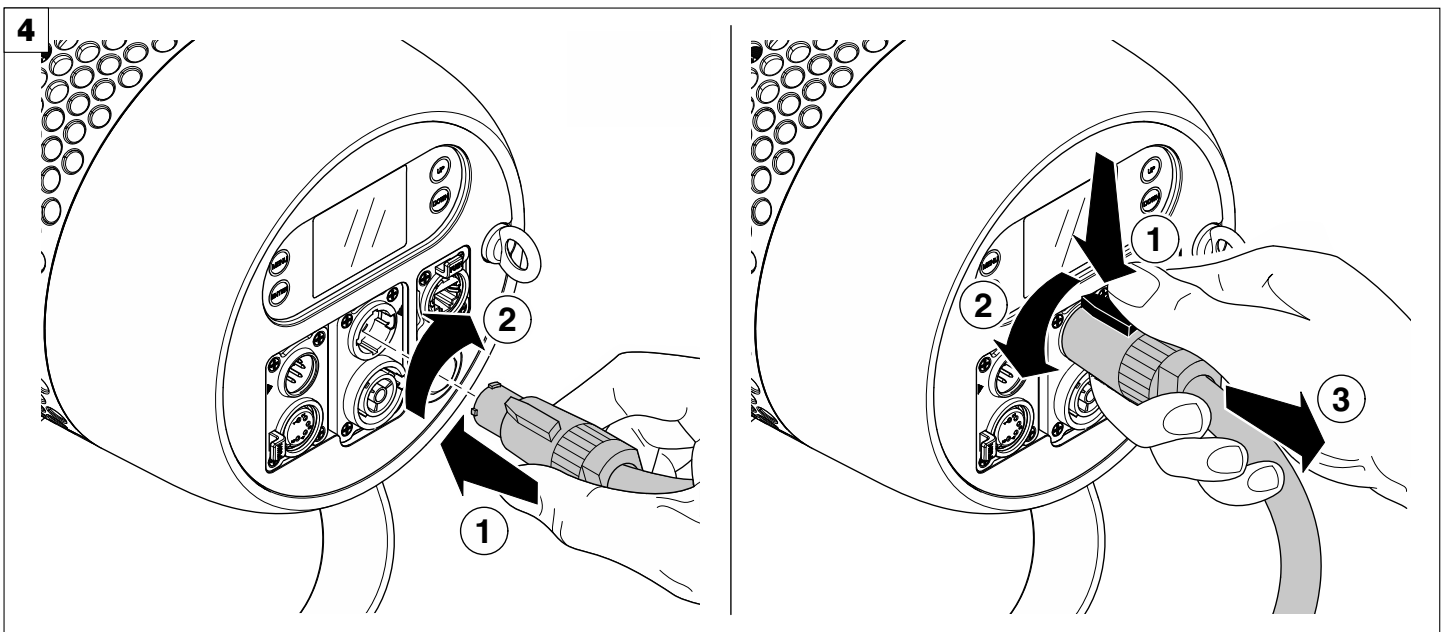

Connecting and disconnecting power cable - Fig. 4

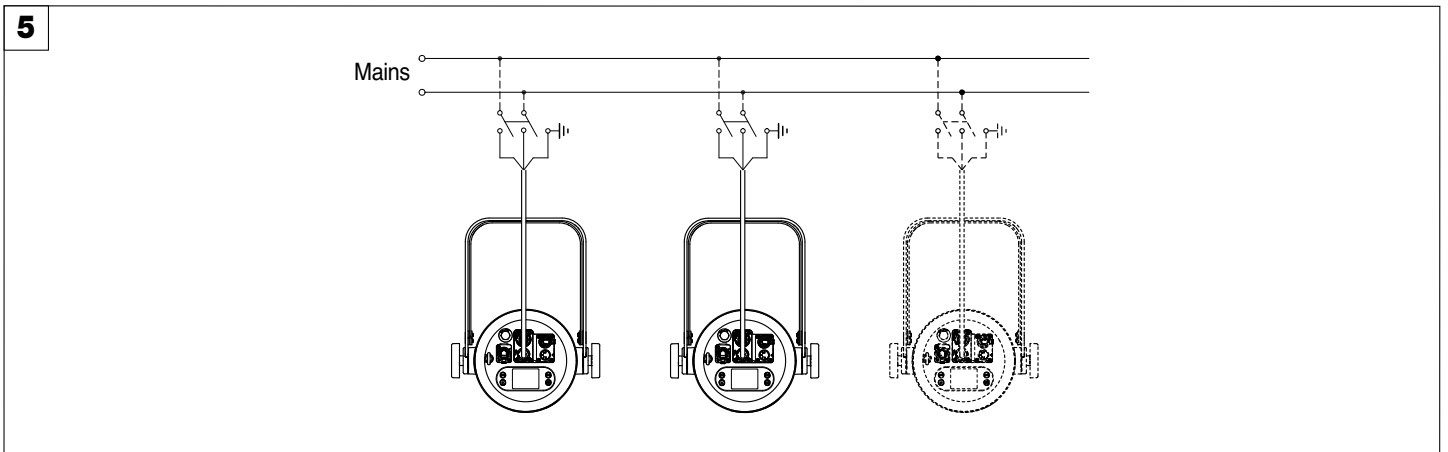

Connecting to the mains supply - Fig. 5

3.3 Connecting the control signal line: DMX / Art-Net

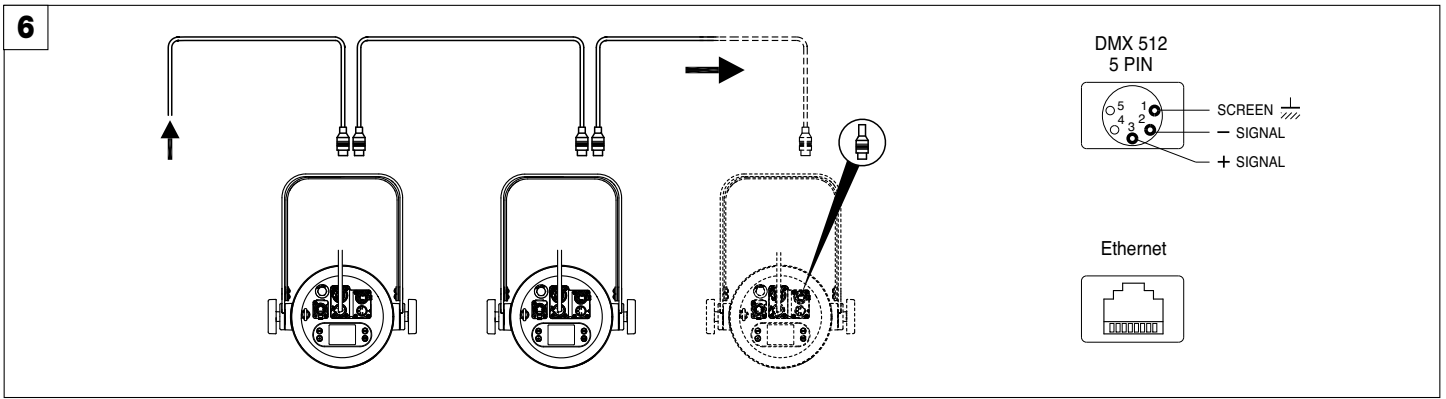

Connecting to the control signal line (DMX) - Fig. 6

Use a cable conforming to specifications EIA RS-485: 2-pole twisted, shielded, 120Ohm characteristic impedance, 22-24 AWG, low capacity. Do not use microphone cable or other cable with characteristics differing from those specified. The end connections must be made using XLR type 5-pin male/female connectors. A terminating plug must be inserted into the last projector with a resistance of 120Ohm (minimum 1/4 W) between terminals 2 and 3.

IMPORTANT: The wires must not make contact with each other or with the metal casing of the connectors. The casing itself must be connected to the shield braid and to pin 1 of the connectors. IP66 line is recommended.

3.4 Switching on the fixture and basic SetUp

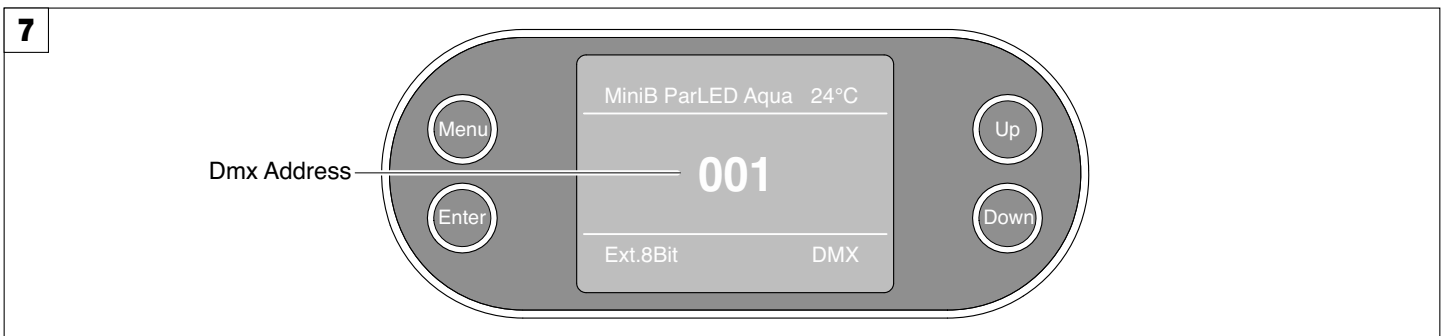

Switching on the projector - Fig. 7

Plug-in the power connector. The projector starts the reset procedure. At the same time, the following information scrolls on the display:



Mini-B ParLED AQUA
Version X.X.X
Date - Hour

The control panel (Fig. 7) has a display and buttons for the complete programming and management of the projector menu. The display can be in one of two conditions: standby or setting status. When it is in standby, the display shows the projector's DMX address.

During the setting status, after a wait time (about 30 seconds) without any key having been pressed, the display automatically returns in standby. It should be noted that when this condition occurs, any possible value that has been modified but not yet confirmed with the ENTER key will be cancelled.

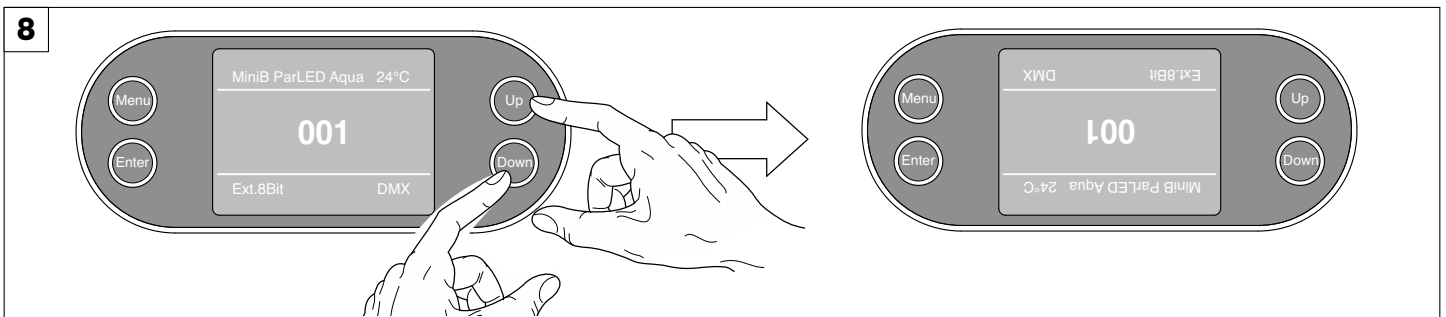

Reversal of the display - Fig. 8

To activate this function, press UP and DOWN keys simultaneously while the display is in standby. This status will be memorised and maintained even for the next time it will be switched on. To return to the initial state, repeat the operation all over again.

Setting the projector starting address

On each projector, the starting address must be set for the control signal (valid addresses from 1 to 501).

The address can also be set with the projector switched off.

Functions of the buttons - Using the menu



Return to the top level



Confirms the displayed value, or activates the displayed function, or enters the successive menu.









Increases the value displayed (with auto-repetitions) or passes to the previous item in a menu.



Decreases the value displayed (with auto-repetitions) or passes to the next item in the menu.

IMPORTANT: To Unlock the display press the buttons sequence UP – DOWN – UP – DOWN – ENTER.

USING THE MENU:

- 1) Press MENU  once – “Main Menu” appears on the display.
- 2) Use the UP  and DOWN  keys to select the menu to be used:
 - Setup: To set the setting options.
 - Option: To set the operating options
 - Information: To read the counters, software version and other information.
 - Manual Control: To trigger the test and manual control functions.
 - Test: To check the proper functioning of effects
 - Advanced: Access to the "Advanced menu" is recommended for a trained technical personnel.
- 3) Press  to display the first item in the selected menu.
- 4) Use the UP  and DOWN  keys to select the MENU  items.

Setting addresses and options with the projector disconnected

The projector's DMX address, as well as other possible operating options, can also be set when the appliance is disconnected from the electricity supply. All that is needed is to press RIGHT  to momentarily activate the display and thus access the settings. Once the required operations have been carried out, the display will switch off again after a wait time of 30 seconds.

4. MAINTENANCE

4.1 Maintenance and Caution

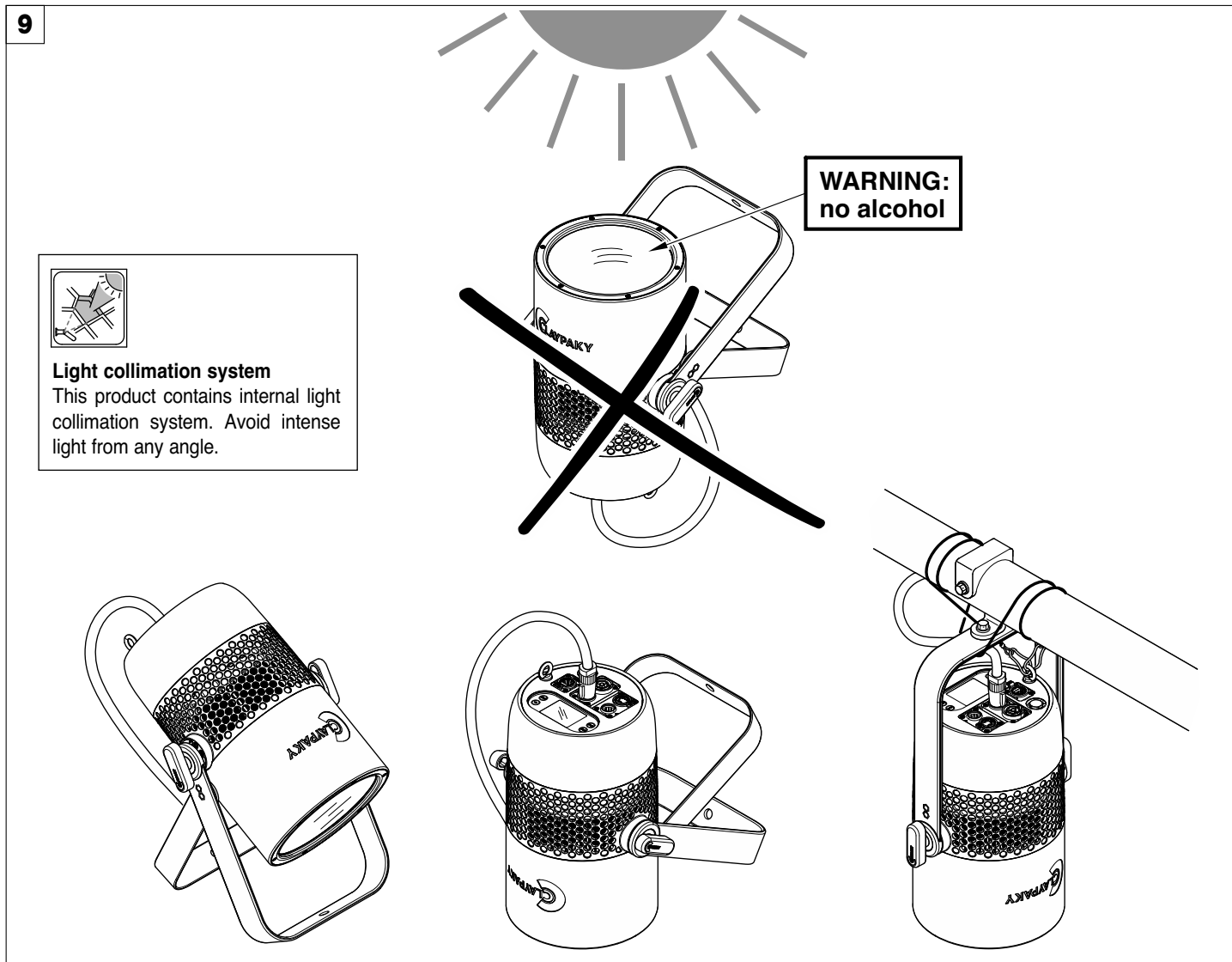

WARNING

- IP 66 fixture
- Failure to completely remove power from fixture prior to servicing can lead to serious injury or death.

For additional service information please contact service@claypaky.it

IMPORTANT

The screws to be removed have rubber sleeve gaskets at the threaded end of the screw. DO NOT LOOSE these. They must be reinstalled when reassembly is done. If these rubber sleeve gaskets are damaged, they must be replaced with exact original equipment (OE) parts, we also suggest to replace the rubber sleeve gasket every 2 years.

To maintain IP66 rating each covers have rubber gasket on it, If any rubber gasket is lost or damaged, they must be replaced by an original equipment (OE) parts, we also suggest to replace the rubber sleeve gasket every 2 years.

CAUTION:

- It is recommended not to use compressed air with more than 4 atmospheres for cleaning the internal parts of the fixture, led board area. This is to avoid damaging electronic components.
- To ensure optimal operation and performance for a long time it is essential to periodically clean the parts subject to dust and grease deposits. The frequency with which the following operations are to be carried out depends on various factors, such as the amount of the effects and the quality of the working environment (air humidity, presence of dust, salinity, etc.).
It is recommended that the projector undergoes an annual service by a qualified technician for special maintenance involving at least the following operations:
 - General cleaning of internal parts.
 - Restoring lubrication of all parts subject to friction, using lubricants specifically supplied by Claypaky.
 - General visual check of the internal components, cabling, mechanical parts, etc.
 - Electrical, photometric and functional checks; eventual repairs.

Cleaning the lenses

Only use neutral soap and water to clean the lenses, then dry it carefully with a soft, non-abrasive cloth. (WARNING: the use of alcohol or any other detergent could damage the lenses).

4.2 Battery removal

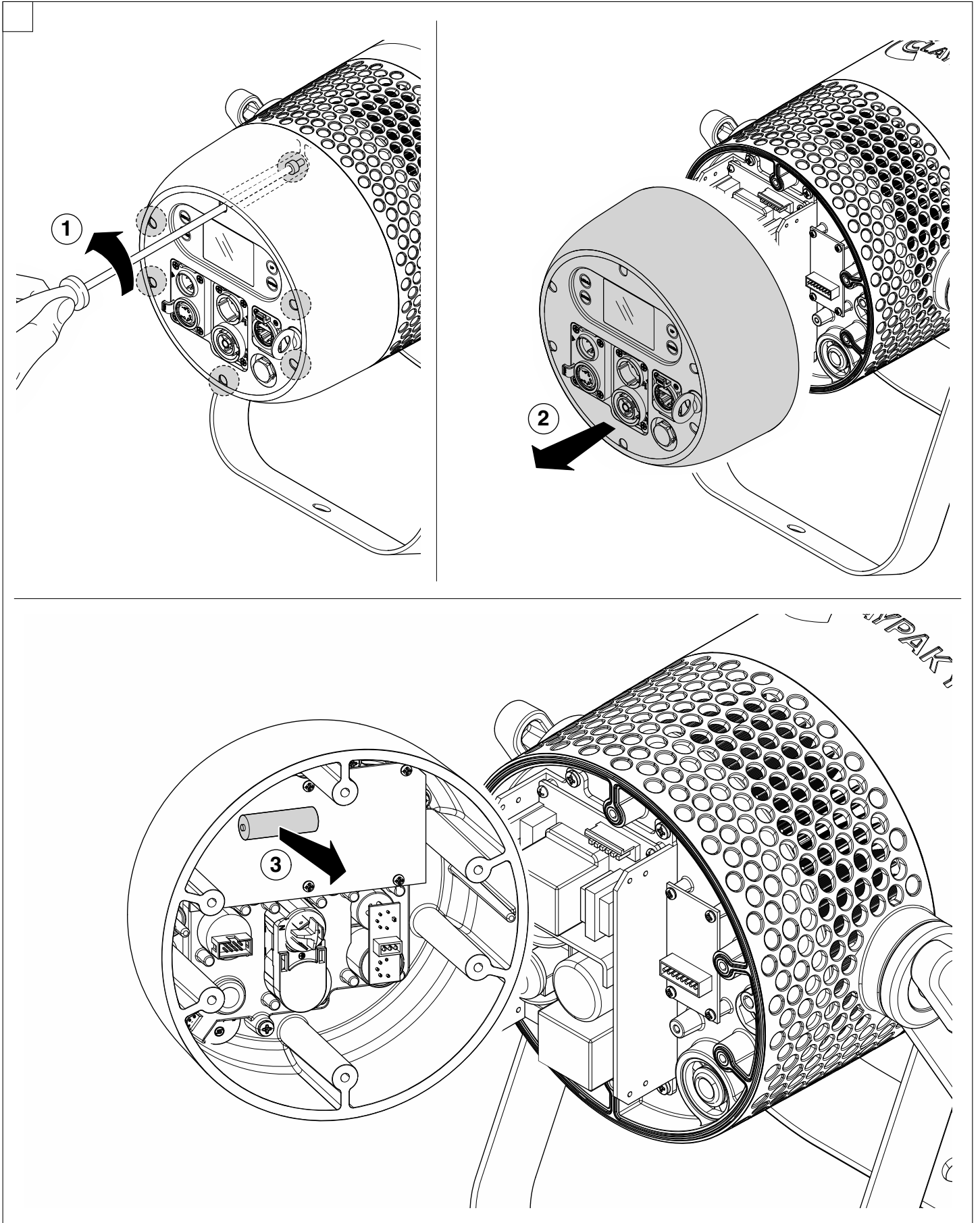

Battery removal - Fig. 10



This product contains a rechargeable battery. To preserve the environment, please dispose the battery at the end of its life according to the regulation in force.

4.3 Opening the covers

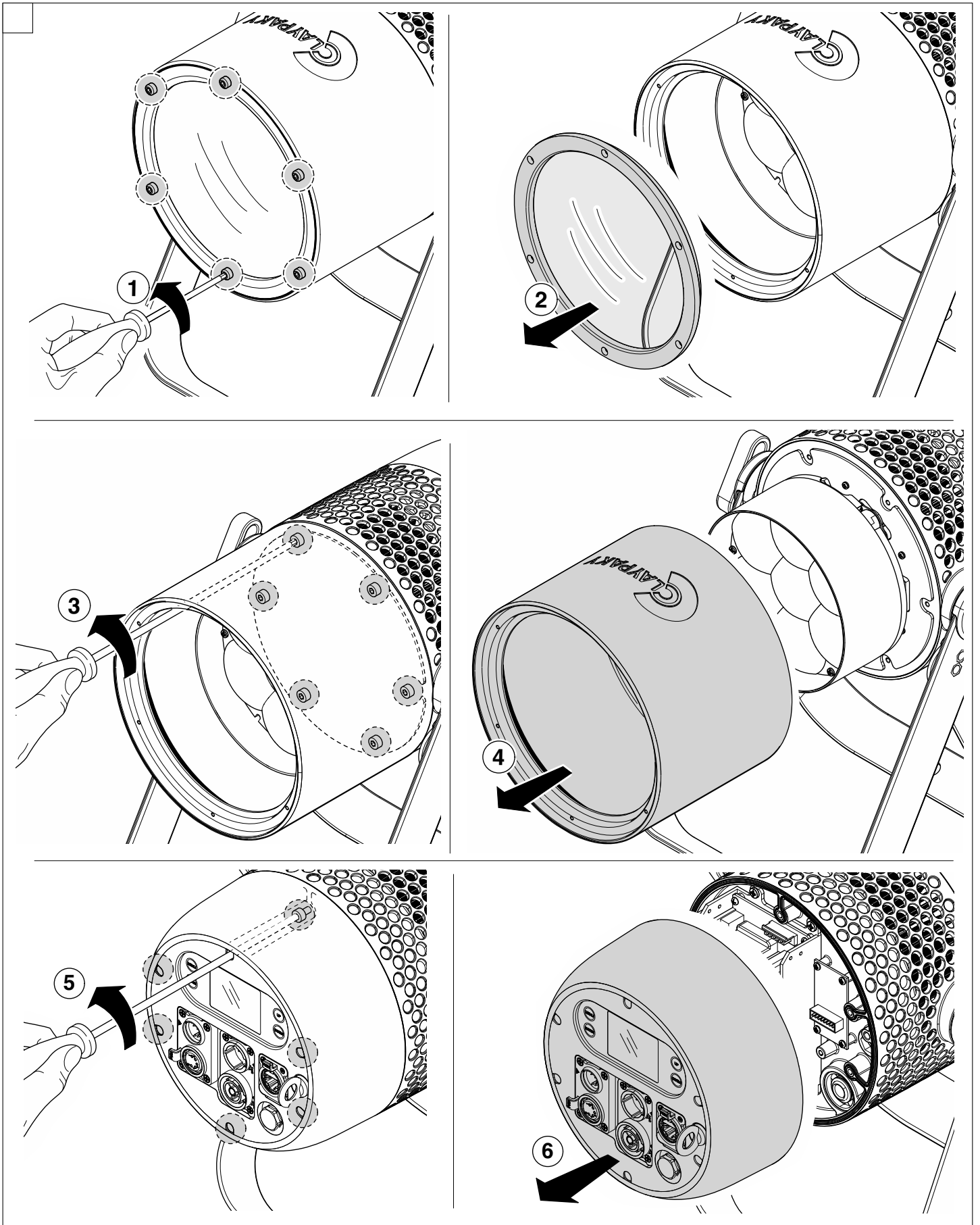

Opening the covers - Fig. 11

5. DIMENSIONS

Mini-B ParLED Aqua

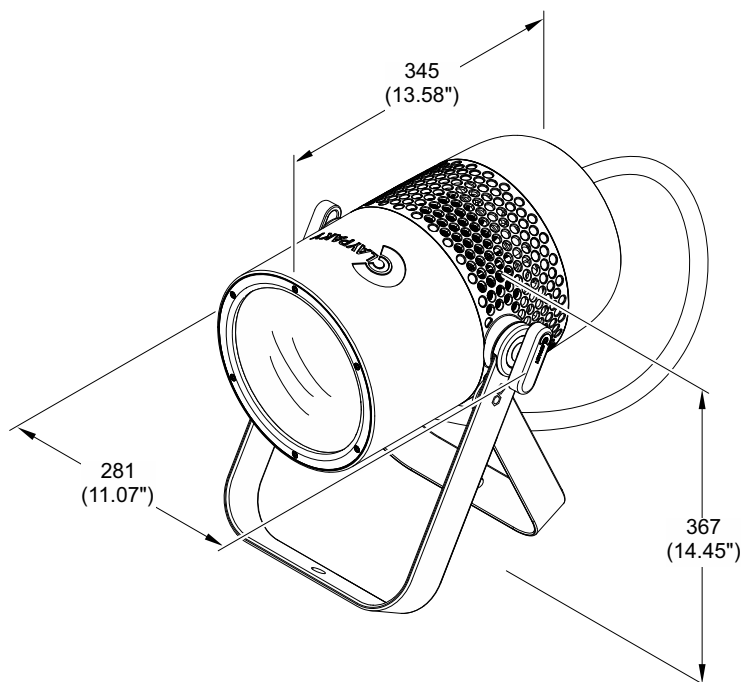

6. CAUSE AND SOLUTION OF PROBLEMS

THE PROJECTOR WILL NOT SWITCH ON				PROBLEMS
ELECTRONICS NON-OPERATIONAL				
DEFECTIVE PROJECTION				
REDUCED LUMINOSITY				
POSSIBLE CAUSES			CHECKS AND REMEDIES	
●		No mains supply.	Check the power supply voltage.	
●	●	LED exhausted or defective.	Call an authorised technician.	
●		Signal transmission cable faulty or disconnected.	Replace the cables.	
●		Incorrect addressing.	Check addresses (see instructions).	
●		Fault in the electronic circuits.	Call an authorised technician.	
	●	Lenses broken	Call an authorised technician.	
	● ●	Dust or grease deposited.	Clean (see instructions).	

