

# Professional Power Amplifier

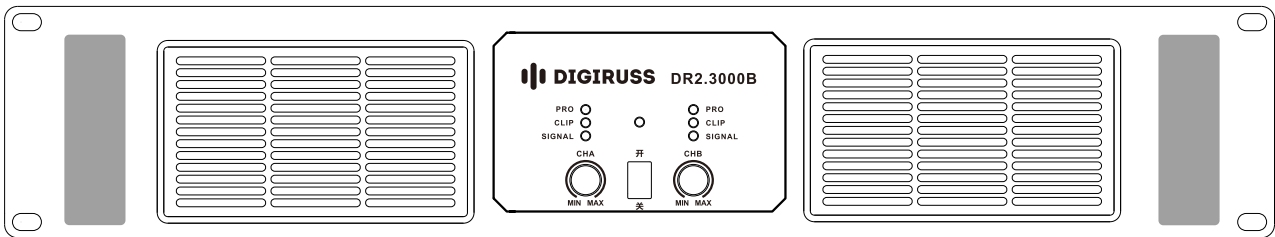

For your protection, Please read these manual, completely before operating the appliance and keep this manual for future reference.

## HI-QUALITY PROFESSIONAL AUDIO PRODUCT

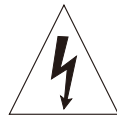
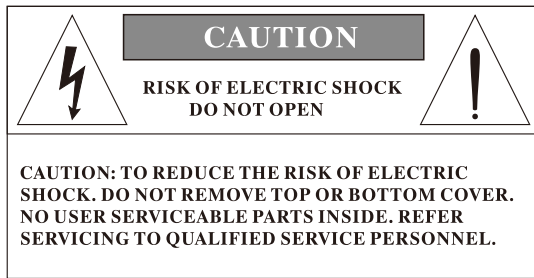

The lightning flash with arrowhead symbol within an equilateral triangle is intended to alert the user to the presence of uninsulated "dangerous voltage" within the product's enclosure, that may be of sufficient magnitude to constitute a risk of electric shock to persons.



The exclamation point within an equilateral triangle is intended to alert the user to the presence of important operating and maintenance (Servicing) instruction in the literature accompanying the appliance.

# IMPORTANT SAFETY INSTRUCTIONS

INSTRUCTIONS PERTAINING TO A RISK OF FIRE, ELECTRIC SHOCK OR INJURY TO PERSONS

**WARNING-**When using electric products, basic precautions should always be followed, including the following:

1. Read all the SAFETY INSTRUCTIONS before using the product.
2. Please use the amplifier under the altitude of 2000 meters, and the non-tropical regions.
3. This product must be earthed. If it should malfunction or break down, grounding provides a path of least resistance for electric current to reduce risk of electric shock.  
This product is equipped with a cord having an equipment-grounding conductor and a grounding plug. The plug must be plugged into an appropriate outlet that is properly installed and earthed in accordance with all local codes and ordinance.  
**DANGER-**Improper connection of the equipment-grounding conductor can result in a risk of electric shock. Check with a qualified electrician or serviceman if you are in doubt as to whether the product is properly grounded. Do not modify the plug provided with the product-if it will not fit the outlet, have a proper outlet installed by a qualified electrician.
4. To reduce the risk of injury, close supervision is necessary when the product is used near children
5. Do not use this product near water-for example, near a bathtub, washbowl, kitchen sink, in wet basement or near a swimming pool or the like.
6. This product may be capable of producing sound levels that could cause permanent hearing loss. Do not operate for a long period of time at high volume level or at a level that is uncomfortable. If you experience any hearing loss or ringing in the ears, you should consult an audiologist.
7. This product should be located so that its location or position does not interfere with its proper ventilation.
8. This product should be located away from heat sources such as radiators, heat registers or other products that produce heat.
9. The product should be connected to a power supply only of the type described on the operating instructions or as marked on the product.
10. This product may be equipped with a polarized line plug (one blade wider than the other). This is a safety feature. If you are unable to insert the plug into the outlet, contact an electrician to replace your obsolete outlet. Do not defeat the safety purpose of the plug.
11. The power-supply cord of the product should be unplugged from the outlet when left unused for a long period of time. When unplugging the power-supply cord, do not pull on the cord, but grasp it by the plug.
12. Care should be taken so that objects do not fall and liquid are not spilled into the enclosure through openings.
13. The product should be serviced by qualified service personnel when:
  - A. The power-supply cord or the plug has been damaged; or
  - B. Objects have fallen, or liquid has been spilled into the product; or
  - C. The product has been exposed to rain;
  - D. The product does not appear to operate normally or exhibits a marked change in performance; or
  - E. The product has been dropped or the enclosure damaged.
14. Do not attempt to service the product beyond that described in the user-maintenance instructions. All other servicing should be referred to qualified service personnel.
15. **WARNING:** Do not place objects on the product's power cord or place it in a position where anyone could trip over, walk on or roll anything over it. Do not allow the product to rest on or to be installed over power cords of any type. Improper installations of this type create the possibility of fire hazard and or personal injury.

## SAVE THESE INSTRUCTIONS

## 高品质音响产品

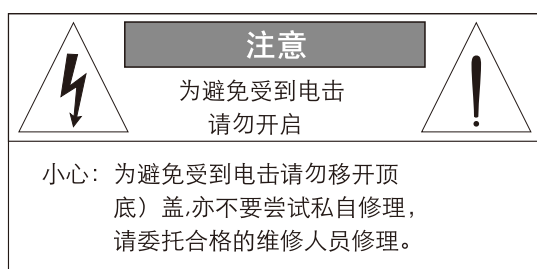

### 重要的安全事项(针对火灾、电击或伤害人体的指示)

**注意：** 使用电器产品时，有以下基本的预防措施，以下包括：

- 1、使用该产品前请仔细阅读全部的安全事项；
- 2、请在海拔2000米以下和非热带地区使用。
- 3、本产品应当接地，如果出现故障时，电流经最小的接地电阻流入大地，以减小电击；本产品的电源线和电源插头都配备安全接地，电源插头应当牢固插入适当的电源座，此电源座应当完全按当地的条例来安装和接地。

**警告：** 接地装置连接不当会导致电击；如果你对产品是否正确接地存在任何疑问，请委托合格电工或维修人员检查；请不要尝试私自更改产品的电源插头，如果不适合电源插座，可委托合格电工安装适当的电源插座。

- 4、为了减小伤害的风险，当产品在小孩附近使用时，要严密监管。
- 5、请勿在湿度很高的地方使用机器，例如靠近浴缸、洗脸盆、厨房水槽、温度很大的地下室或者靠近游泳池和湖泊。
- 6、该产品有可能产生导致永久性听觉丧失的音量，请勿长时间在很大或令人很不舒服的音量下动作。如果你察觉到有任何听力丧失或者耳朵发响，应当咨询听觉病矫正专家。
- 7、该产品应当安装于通风良好的地方。
- 8、该产品必须远离热源，例如电暖炉、电热毯或者其他产生热量的产品。
- 9、该产品的电源类型必须符合操作提示或者产品上标明的类型。
- 10、该产品要配备一条两端的电源线（一端的插片长过另一端）。这是安全装置。如果你无法把电源插头插入电源插座，请联系电工来更换旧插座。请勿破坏电源插头的安全装置。
- 11、长时间不使用时，请把电源线从电源插座中拔出，从电源座拔出电源线时，请勿拉扯电源线，应当抓住电源插头将其拔出。
- 12、细心护理，请勿让杂物或液体从其缝隙掉进机内。
- 13、当有下列情况时，应委托合格维修人员修理。
  - A、电源线或电源插头已被损坏；
  - B、杂物或液体已掉进机内；
  - C、产品已被雨淋；
  - D、产品已不能正常操作或在演出中出现明显变化；
  - E、产品已跌坏或外观损坏。
- 14、当出现没在用户维修指南中描述的情况时，请勿尝试私自修理，应当委托合格的维修人员修理。
- 15、**警告：** 勿让重物积压或踩踏电源线，切忌拉、拔或强力扭曲电源线。  
勿滥用电量线，不合格的电源线可能导致火灾或对人造成伤害。

请保存这些安全事项



# CATALOGUE



Catalogue .....	1
Installation & operating instruction .....	3
Functions & controls instruction .....	5
Technical specifications .....	11
Connector cables .....	12



 **目 录** 

目录 .....	1
安装和操作说明 .....	3
功能和控制说明 .....	5
技术指标 .....	11
连接线材 .....	13

## Installation & operating instruction



✓ *Mains power connection.*

*Before connecting the amplifier to the mains power socket, make certain that the voltage corresponds with that indicated on the rear of the unit (AC220V ± 10%). Before connecting the power cable to the mains, always make certain that it is not damaged and that there are no bare wires, always connect the power cable to the amplifier before switching it on and only remove the cable after switching it off.*

✓ *Switching on and off*

*In an audio system, it's always better to switch power amplifiers on last and off first. Remember to switch off the amplifier before connecting it to or disconnecting it from other units and to switch always on first the mixer and then the amplifier: in this manner, peaks which are annoying and sometimes dangerous particularly for the loudspeakers enclosures are avoided. It is normal for the LEDs to light up for a few moments when switching on.*

✓ *Handling*

*Do not force knobs and connectors, as they could be damaged if treated with excessive force.*

✓ *Connections and prevention of possible interference*

*Avoid installing your equipment near radios, televisions, etc, since they could cause noisy disturbance. When connecting the other units in your sound system, watch out for so-called earth-loops, which can cause hum. In the event of interference, try using the EARTH switch on the amplifier's rear panel.*

✓ *Connector cables*

*To connect the amplifier to the mixer, always make certain to use only signal cables (screened cables made up of two wires plus a braid screen), not power cables (speaker cables, normally made up of two wires, usually with a greater cross-section): to connect the amplifier to the loudspeaker enclosures, always use power cables, not signal cables, as in the latter case in fact, the power from the amplifiers would be partially dispersed because of the cable's smaller cross-section. Take care of the connector cables. Always hold them by the connectors, avoiding pulling the wire and avoid knots and twists when coiling them: this gives the advantage of increasing their life and reliability.*

✓ *Air circulation for cooling*

*Amplifier's correct cooling is ensured by internal fans, the speed of which is controlled by special sensors (the speed is proportional to output power, remember never to block the air vents in any way: the air necessary for cooling passes through these. If the amplifier is kept in a flight-case during use, make certain that it has sufficient openings at both the amplifier's air vents. Avoid locating it in very small spaces which don't allow correct air circulation.*

✓ *Warning High Voltage*

*Please attention fan-out high voltage, and polarity, not short circuit.  
When the product is work, don't touch the output connector for safety.*

## 安装及操作说明

### 主电源的连接

- ① 将功放连接到电源插座之前，请确认电源电压符合功放后板下所标注的电压要求，（AC220V±10%）。将电源接上电源插座之前，请确认电源线没损坏。在开机前连好电源线；在关机后拔掉电源线。

### 开关机



- ② 在音响系统里面，功放是最迟打开及最早关闭。在连接其它设备时，要关掉功放。先打开调音台，后打开功放。按此顺序，避免对音箱造成损害。

### 注意

- ③ 为了保护好电源线和连接线，不允许用力挤压电源线和连接线。

### 抗干扰

- ④ 避免干扰，切勿将音响设备安装在靠近无线电装置，电视机等等的地方。在你连接音响设备时，如果有交流声（嗡嗡响），尝试打开功放后板上接地开关。

### 不得受雨淋或水溅

- ⑤ 勿将本机放置在湿度很高的地方，不能受雨淋或水溅。有水的物体不能摆在本机的上方。避免在本机附近喷洒杀虫剂或使用化学品如酒精、涂料、稀释剂、松香水等溶剂抹机箱。

### 风槽

- ⑥ 为了保证功放的正常工作，切勿阻塞风槽（进风口和出风口）如果功放在很恶劣的环境下使用，请确认在功放周围有足够的空间。避免将功放安置于狭小，不利于空气流通的地方。

### 注意高压

- ⑦ 注意输出端高压、极性，请勿短路。在本机工作时，请勿触摸本机的输出端子，否则有可能对人造成伤害。

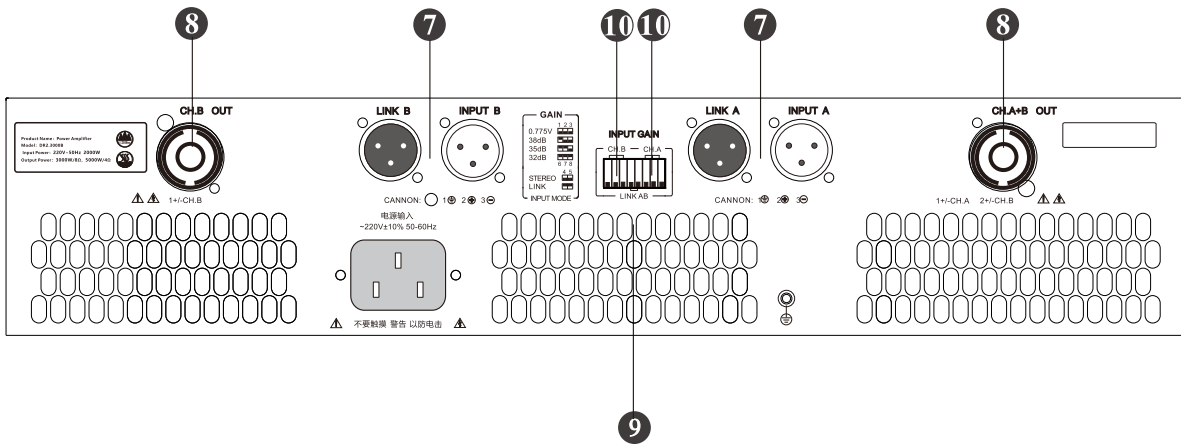
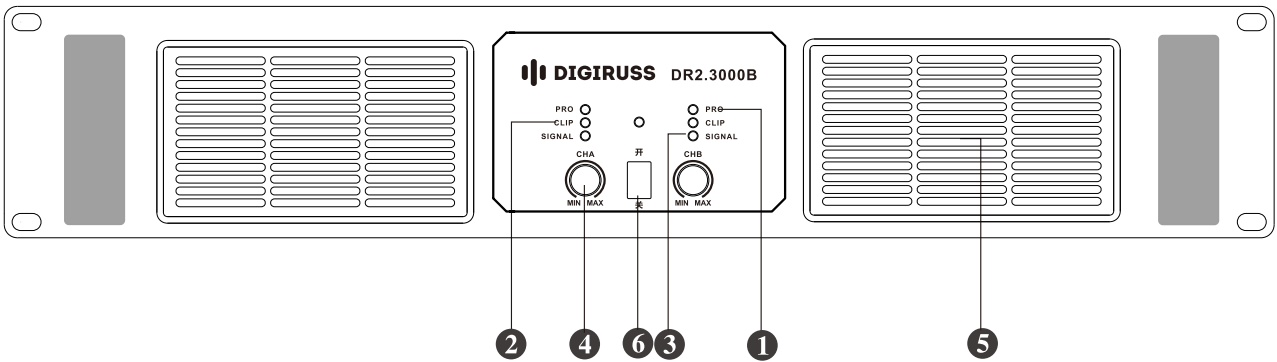

### 1 PROTECT LEDs

Protection pilot lights

If these LEDs light up, this indicates that one of the various protections safeguarding the different sections of the amplifier and the loudspeaker enclosures has tripped due to an operating fault. In these cases, the power output is normally switched off until normal operating conditions are restored.

The following is a description of all the series protections

- 1) Switch on AC soft working Protection: Limit the electric current when start up, don't affect the others equipments or out the rush of circuit inside.
- 2) Delay the link load: protect the loudspeaker, keep silence when start up.
- 3) Circuit damage protection: midpoint excursion and output the AC, limit the damage to extend.
- 4) Limit the output current Soft protection: The loading impedance is low and too drastic signal; it can protect the loudspeaker and amplifier.
- 5) Clip and compress protection: When input too big signal, the clip output is distortion, it is easy to damage the speaker unit; this circuit can check the compress signal to protect the loudspeaker.
- 6) Short Circuit Protection: trips in the event of a short-circuit or overload, limiting the output current.
- 7) Over hot protection: In high temperature and low overload state, the temperature grow hot quickly, the protect will work to cut the load over 80°C. The amplifier will rework below 70°C.
- 8) Switch off Protection: First turn off the overload when switch off, it keep the loudspeaker silence out of the rush.



Some protection situations require the amplifier to be switched off and then back on for normal operating conditions be restored.

### 1 保护指示灯

保护指示灯点亮。

如果保护指示灯点亮，这表明功放的保护电路由于负载有问题或者其它方面故障而动作了，保护电路通过继电器切断功放的输出。

产品的保护电路说明如下：

- 1) 电源开机交流软启动：抑制启动电流，不影响其它设备工作和保护机内电路免受冲击；
- 2) 开机延时接载：保护音箱免受冲击，无声开机；
- 3) 直流输出断载保护：中点漂移和有直流输出时，防止音箱受冲击而损坏；
- 4) 过流自动跟踪输出限流软保护：当负载阻抗过低和输入信号过激时，对功放本身和音箱保护；
- 5) 削波压缩保护：当输入信号过大时，使功放削峰失真输出，容易损坏喇叭，本电路能自动检测压缩信号保护音箱；
- 6) 负载短路保护：当输出短路时，短路电流过大，保护自动切断输出，保护功放，当短路解除后自动恢复；
- 7) 过热保护：当在高温环境和低负载工作时，机内温升较快，当功率管温度超过80°C时，过热保护自动起控，切断负载，当温度低于70°C时自动恢复工作；
- 8) 关机保护：关机时先切断负载，实现无声关机保护音箱免受冲击。



有些保护电路需要把功放关掉然后重开，才能恢复正常的操作状态。

### ② **LIMIT LEDs**

*Amplifier "status" indicators: these LEDs are able to indicate for channels A and B, the operation Of the internal limiter, when inserted, or the clipping of the amplifier:*

*These 2 LEDs are POST-LEVEL: in other words they display the status of the signal when it has already been regulated by the input level controls.*

### ② **压限指示灯**

功放状态指示灯。压限指示灯点亮表明功放内压缩保护电路开始动作，功放的输入信号过大，应该要减小。可见，压限指示灯也反映了经音量电位器控制后的信号幅度大小。

### ③ **SIGNAL LEDs**

*Signal "status" indicators: these LEDs are able to indicate for channels A and B, a signal Presence in the inputs of the amplifier.*

### ③ **信号指示灯**

当功放有输出时，信号指示灯会闪烁，指示功放开始输出。

### ④ **LEVEL**

*Control of the input level of the external signal: operates with continual values which vary From "fully closed" (position "MIN" -the signal is not fed to the amplifier sections ) to "fully open" (position "MAX" -the signal is sent to the amplifier sections at the same level as that with which it arrives at the input).in other words, this control operates as an attenuator of the signal fed to the amplifier.*

### ④ **音量电位器**

控制信号输入电平：音量电位器可以由“MIN”的位置旋转到“MAX”的位置；

音量电位器置于“MIN”时，没有信号输入功放；

音量电位器置于“MAX”时，信号全部输入功放；

音量电位器就是一个输入功放信号的衰减器。

### ⑤ **AIR VENTS**

*Amplifier cooling system air in/out vents.*

*The fan of the cooling system create a flow of air with front to back direction: this means that the Air is taken from the front panel to the back cover, and having cooled the heat sinks and transformer. through the opening on the back side. Care must always be taken to avoid blocking these openings and to never place the amplifier in a position which does not allow sufficient air circulation.*

**5 通风孔**

功放散热系统空气进出气孔。

散热系统：由前面板开进风孔，后板开出风孔，创造了由前向后的空气流通条件，增强通风量，提高了散热效率。

**6 POWER ON**

*ON/OFF switch with indication LED. (Active LED)*

**6 电源开关**

打开及关闭功放电源，打开时电源指示灯点亮。

**7 INPUTS**

*Each channel has a XLR input, and a XLR input for parallel output.*

**7 信号输入端口**

每个通道各有1个母卡侬输入座和1个并联输出的公卡侬输出座。

**8 OUTPUTS**

*STEREO outputs : output of CHA : the "1+" is the "⊕" of CHA , the "1-" is the "⊖" of CHA , the "2+" is the "⊕" of CHB , the "2-" is the "⊖" of CHB .*

*output of CHB : the "1+" is the "⊕" of CHB , the "1-" is the "⊖" of CHB .*

**8 功率输出端口**

CHA 输出座 :1+为 CHA “⊕”，1-为 CHA “⊖”，2+为 CHB “⊕”，2-为 CHB “⊖”；

CHB 输出座 :1+为 CHB “⊕”，1-为 CHB “⊖”；

接法1:

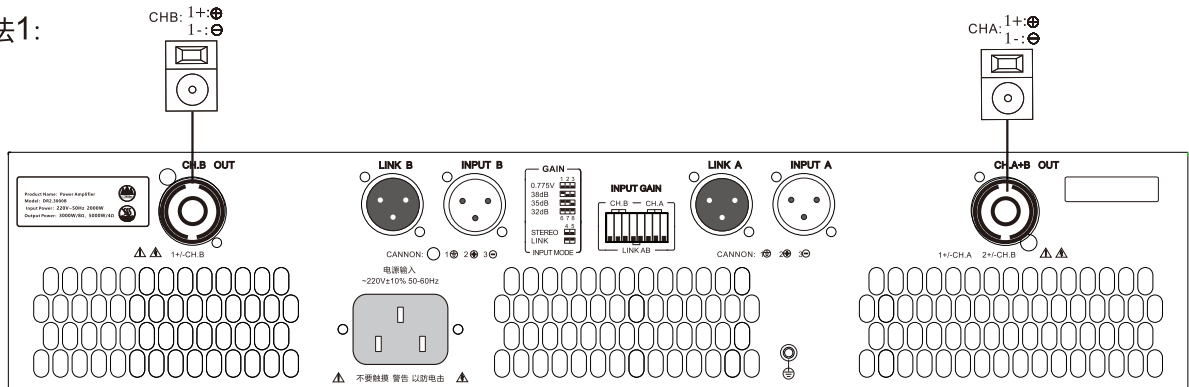

接法2:

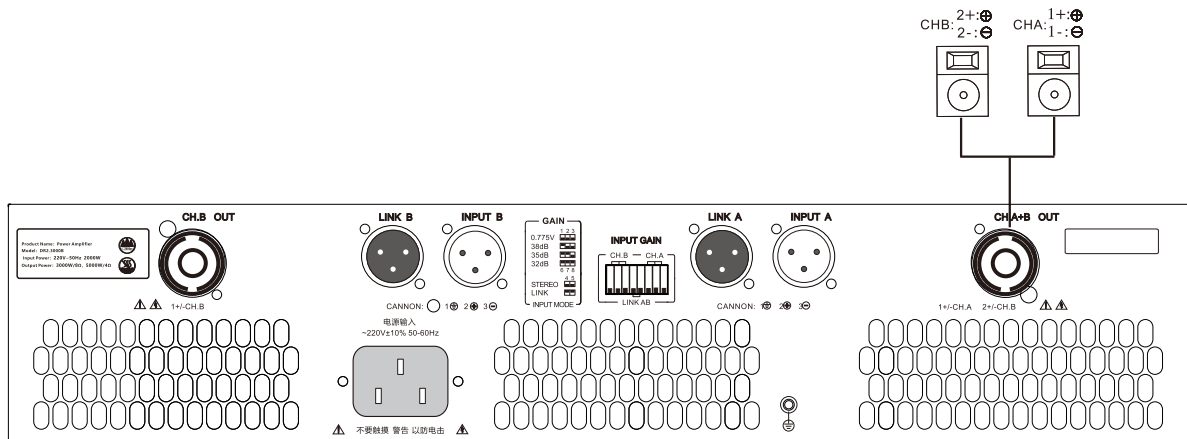

9 STEREO/ PARALLEL selector

Selector for the amplifiers 2 operating setting: allows to decide how use the amplifier in the audio setup, Connect with other units(crossovers, other amplifiers, loudspeaker enclosures).



This control should only be used when the amplifier off, otherwise the loudspeaker's Components could be damaged.

A) STEREO

With the STEREO setting, 2 separate signals are treated separately by each channel of the amplifier.

9 立体声/并联模式选择开关

设定功放两种状态：立体声和并联。在音响系统中利用此开关，可以方便搭配其它设备，例如：调音台、电子分频器、音箱、功放。





这个开关仅能在功放关闭时才能使用，否则有可能对喇叭单元造成冲击。

### A) 立体声

设定在立体声状态下，2个独立的信号分别由2个通道分别放大。

开关处于关闭状态时，为立体声状态。示意图如下：

### B) PARALLEL MODE

*With the parallel setting, when inputting one signal, the parallel channel can output signal at the same time.*

*When switch 4&5 open, CH.A and CH.B are parallel.* 

### B) 并联模式

设定在并联状态下，输入1个信号，并联通道同时有信号输出。

4 & 5开关开启（向上拨）时，IN.A和IN.B 并联。示意图如下：

## 10 GAIN adjust

*According to different file, it can set different gain for each channel (0.775V/38dB/35dB/32dB).*

## 10 增益调节

可根据要求设置每通道功放的增益 (0.775V/38dB/35dB/32dB)。

**GAIN Setting**      0.775V       38dB       35dB       32dB 

## AMP SERIES TECHNICAL SPECIFICATIONS

### Power specifications

EIA AC220V output power 1KHz Max THD 0.5% Test mono	MODE	8Ω	4Ω	Weight
	DR2.2400B	2*2400W	2*3600W	16kg
	DR2.3000B	2*3000W	2*5000W	16kg

### ELECTRICAL SPECIFICATIONS

#### POWER SPECIFICATIONS

Amplifier	Gain	0.775V/38dB/35dB/32dB
	Impedance	20kΩ (balanced, stereo) 10kΩ (unbalanced, parallel)
Frequency response	< ± 0.5dB (8Ω 30W 20-20kHz)	
Slew rate	> 20V/us (8Ω 1kHz)	
Damping factor	> 300 (8Ω 1kHz)	
Crosstalk	> 60dB (8Ω 1kHz)	
S/N	> 100dB (A weighted)	
Total harmonic distortion (THD+N)	< 0.08 % (8Ω 30W)	
Inter-modulation distortion (IMD)	< 0.3% (8Ω 30W)	

#### GENERAL SPECIFICATIONS

PROTECTIONS	Amplifier Speakers	POWER ON/OFF protection Transistor thermal protection Short circuit protection Sensor for current on outputs Limiter
CONTROLS	Front panel	ON/OFF switch Signal level control for each channel
	Back panel	STEREO/PARALLEL selector Input sensitivity adjust
INDICATORS	ON: 2 green; protect: 2 red; clip: 2 yellow; signal: 2 green; parallel: 2 yellow	
CONNECTORS	Input	4 × Neutrik XLR connectors
	Output	2 × Neutrik Speakon connectors
POWER SUPPLY	See label on the apparatus	
DIMENSIONS(W×H×D)	483mm×88mm×475mm	

## Connector cables

The following diagrams illustrate the wiring of the various types of sockets that can be used with the power amplifiers.

To connect the amplifier to the mixer, always make certain to use only signal cables (screened cables made up of two wires plus a braid screen), not power cables (speaker cables, normally made up of two wires, usually with a greater cross-section): the use of unscreened cables could in fact cause annoying buzzes and background noise. The amplifier's inputs are in fact balanced and therefore designed in such a way that any interference on the line is eliminated or at least greatly reduced. We therefore always suggest the use of balanced cables for microphones and line units whenever possible.

To connect the amplifier to the loudspeaker enclosures, always use only power cables, not signal cables, as in the latter case in fact, the power from the amplifiers would be partially dispersed because of the cable's smaller cross-section.

Take care of the connector cables. Always hold them by the connectors, avoiding pulling the wire and avoid knots and twists when coiling them: this gives the advantage of increasing their life and reliability. Check your cables periodically, making certain that they are in good condition, that the connectors are correctly wired and contacts perfectly efficient: in fact, many problems and setbacks (faulty contacts, ground hum, disturbance, etc.) are due to the use of unsuitable or faulty cables.

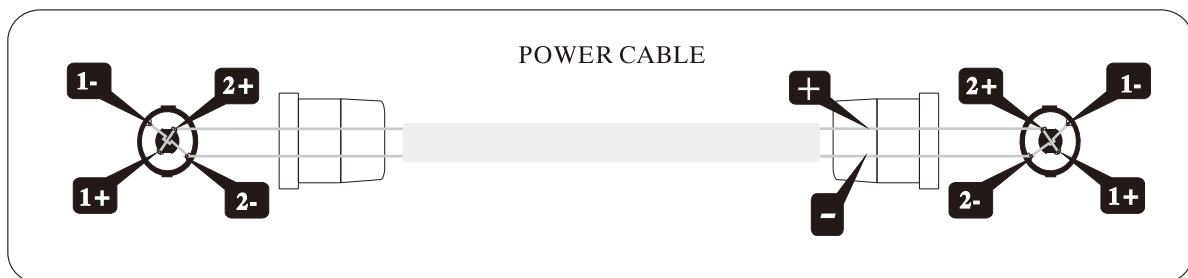
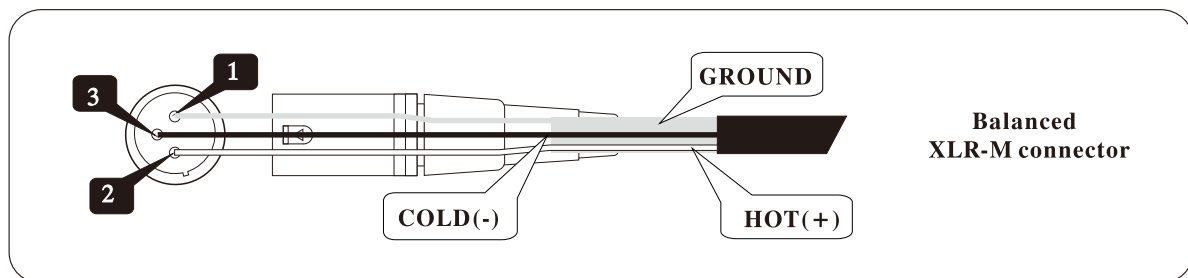

## 连接线材

下面说明各系列功放上使用各种线材:

连接功放和调音台,只使用信号线(这种线由一个屏蔽网和屏蔽网内的两根线组成),不要使用电力电缆(音箱线,截面积较大,由两根线组成)。使用没有屏蔽网的线材会引起讨厌的嗡嗡声和背景噪音。各系列功放都是平衡输入的,这种设计会消除或者减少输入线上的干扰。很多知名专家一直以来都建议尽量在连接功放与其它前置音频设备时采用平衡输入的方式。连接功放和音箱,通常只使用电缆,而不是信号线,因为截面积较小的电缆会耗散功放输出功率。注意保护连接线材。通常抓住线材末端而提起它,避免在卷起时,拉扯和强力弯曲线材,因为这样会缩短它们使用寿命和降低可靠性。定期检查线材,检查线材是否正确和接触是否良好。实际上,很多问题是由于连接线材有问题而引起的。

