

CIN'K - 325LF

CIN'K - 2000/2500 W TUNGSTEN



- **Type:** Single lens luminaire
- **Source:** 2000/2500 W Tungsten
- **Optics:** 250 mm Fresnel lens

Single lens

2K Fresnel designed specifically for theatres

Cin'k's 250 mm lens gives an output which exceeds that of comparable 300 mm fixtures, and its theatre-inspired front cassette has no distracting light spill. An ideal tungsten source for theatres and opera houses, large venues and rental houses.

Features

- **Theatre front cassette:** no light spill to distract audiences or performers
- **Colour runners:** double runners to hold accessories and colour filters
- **Focus reference:** index for easy focus reference
- **Tilt reference on hanging yoke:** index for rapid re-positioning

Optical

- **250 mm lens:** light output equivalent to 'studio' 300 mm fixtures

Construction

- **Made in France :** fully manufactured in Robert Juliat premises retaining complete control over all aspects of quality
- **Air vents:** efficient cooling with no light spill
- **Bodywork:** strong sheet metal construction for durability
- **Moving parts:** smooth at all times, even when hot
- **Captive knobs and handles:** additional security when working at height or in transit
- **Access:** easy access to lamp house and lenses through front opening for fast and efficient maintenance
- **Easy access to all parts:** easy cleaning, re-lamping and maintenance
- **Removable assemblies:** fast-plug cable connectors and complete component assemblies (mirror, condenser set and lamp house assembly) save maintenance and cleaning time
- **Specially designed handle:** for fast cable changing without having to go inside the unit
- **Safety grid:** earthed safety grid fitted as standard
- **Safety first:** front accessories safety cable attachment point

Picture:325LF

DSEN015_325LF - 23/03/2022

Robert Juliat reserves the right to change or alter any of the items detailed on this page, to increase or improve manufacturing techniques without prior notice.

Robert Juliat S.A.S., 32 rue de Beaumont, 60530 Fresnoy-en-Thelle - France
Telephone : +33 (0)3 44 26 51 89 - fax : +33 (0)3 44 26 90 79 - info@robertjuliat.fr
www.robertjuliat.com



ROBERT JULIAT

Source



- **Lamp type:** Tungsten
- **Socket:** G22

Admissible lamps	Power *	Lumen output*	Colour temperature*	Life*
LIF: CP92	2 000 W	52 000 lm	3200K	400 h
LIF: CP91	2 500 W	65 000 lm	3200K	400 h

(*) manufacturer's data

Optics

Characteristics

- **Type:** Single lens
- **Beam range:** 7° to 52°
- **Lens:** 250 mm Fresnel lens

Gel filter

- **Shape:** Square
- **Standard size:** 333x333 mm (13.1x13.1 in)

Photometrics

with LIF: CP91 source

• Optics @ 17°

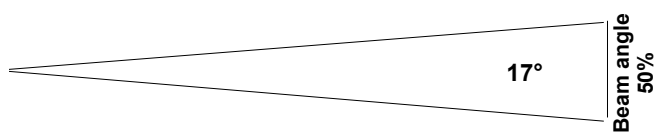
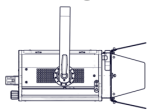

Beam intensity
200 000 cd

Distance	5 m	10 m	15 m	20 m	25 m	30 m
Diameter	1.5 m	3 m	4.5 m	6 m	7.5 m	9 m
Illumination	8 100 lux	2 050 lux	890 lux	510 lux	330 lux	230 lux
Distance	15 ft	35 ft	50 ft	65 ft	80 ft	100 ft
Diameter	4.5 ft	10.5 ft	14.9 ft	19.4 ft	23.9 ft	29.9 ft
Illumination	890 fc	170 fc	85 fc	48 fc	32 fc	21 fc

Dimensions and weight

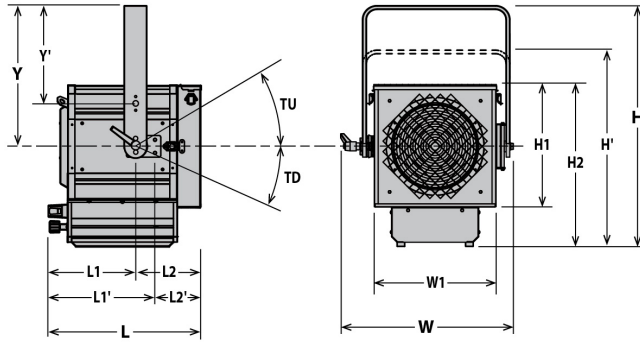

Weight: 17 kg (37.4 lbs)

Height	Length	Width	Yoke	Tilt
H= 510 mm (20.1 in)	L= 425 mm (16.7 in)	W= 465 mm (18.3 in)	Y= 270 mm (10.6 in)	TU= TBD°
H'= 630 mm (24.8 in)	L1= 250 mm (9.8 in)	W1= TBD mm (0 in)	Y'= 390 mm (15.4 in)	TD= TBD°
H1= TBD mm (0 in)	L1'= 290 mm (11.4 in)			
H2= 410 mm (16.1 in)	L2= 175 mm (6.9 in)			

Shipping

- **Weight :** 20 kg (44 lbs)
- **Volume :** .14 m³ (4.94 ft³)

Installation

- **Minimum distance to illuminated surface:** 2.7 m (8.9 ft)
- **Operating position:**

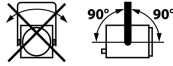

Construction

- **Housing:** Steel sheet - Aluminium
- **Colour:** Black
- **Cooling:** Convection cooling
- **Maximum ambient temperature (Ta):** 40°C (104°F)
- **Maximum case temperature (Tc):** 250°C (482°F)
- **Total heat dissipation:** 6 826 BTU/h
- **Ingress Protection (IP) rating:** IP20

Electrical compatibility

- 230/240 V - 50 Hz
- ~~115/120 V - 60 Hz~~

Power input



- **Type:** attached power cord
- **Cable:** H07RNF 3G1.5
- **Length:** 3 m (9.8 ft)
- **Power connector:** CEE 7/7 (2P+E NF/Schuko)

Power consumption

Voltage	Frequency	Current	Power
230 V	50 Hz	9 A	2000 W
230 V	50 Hz	11 A	2500 W

Warranty

- **Fixture: 2 years**
See General Sales Condition on website

Approvals















Model

325LF	2000/2500 W Tungsten Single lens luminaire - G22 socket - 250mm Fresnel - 325LF Cin'k
--------------	---

Options

PCP1716A	16A blue 2P+E 6h IEC60309 power connector	
-----------------	---	---

Accessories

PF325	333x333mm metal filter holder - Poids: 0.52 Kg 1 included	
G325L	333x333mm safety grid - Poids: 0.44 Kg 1 included	
CP91	CP91 - G22 2500W 230V 400h 3200K lamp	
CP92	CP92 - G22 2000W 230V 400h 3200K lamp	
PFR325	600x600 mm extended metal filter holder with 4 clips - Poids: 1.11 Kg	
CF325	4 rotating leaves on a rotating barndoor - 333x333mm (without safety cable) - Poids: 2.11 Kg	
PFR CF325	Extended filter holder and rotating barndoor set - 333x333mm	
T/326LFV	326LFV lamp compartment (P.S.U. required) - Poids: 10.48 Kg	
T/350LF	350LF lamp compartment - 3 meter power cable with CEE 7/7 (2P +T NF/SCHUKO) connector	
T/350LFV	350LFV lamp compartment - fan cooled front cassette- 3 meter power cable with CEE 7/7 (2P+T NF/SCHUKO) connector	
876	Hook clamp 40x10mm with 28mm M10 screw for Ø35 to 50mm pipes - SWL: 50Kg - Poids: 1.25 Kg	
880	Hook clamp 40x10mm with 28mm M10 screw for Ø50 to 63mm pipes - SWL: 50Kg - Poids: 1.36 Kg	
CS2	Safety cable Ø3 mm L= 600mm - SWL: 75 Kg	