

LUTIN - 306LPB

306 - 1000 W TUNGSTEN



- **Type:** Single lens luminaire
- **Source:** 1000 W Tungsten
- **Optics:** 150 mm Pebble lens

Single lens

Compact 3-in-1 fixture

Lutin is a multi-purpose 1K Pebble lensed fixture providing ideal softlight for smaller venues, schools and rental companies. Lenses can be quickly changed to PC or Fresnel for extra versatility.

Features

- **Theatre front cassette:** no light spill to distract audiences or performers
- **Colour runners:** double runners to hold accessories and colour filters
- **Barn door:** unique rotating barn door with 4 individually rotating blades – makes even the most difficult angle possible
- **Focus adjustment:** smooth focus adjustment from rear, even when lantern is hot, for a longer lamp life
- **Focus reference:** index for easy focus reference
- **Tilt reference on hanging yoke:** index for rapid re-positioning

Optical

- **Choice of 3 lenses:** fresnel, Plano-Convex & Pebble-Convex – no tools required
- **A clean beam:** paint and light traps to avoid light leaks

Construction

- **Made in France :** fully manufactured in Robert Juliat premises retaining complete control over all aspects of quality
- **Air vents:** efficient cooling with no light spill
- **Bodywork:** strong sheet metal construction for durability
- **Internal cable guide:** to prevent cables from becoming entangled in movable lamp tray
- **Moving parts:** smooth at all times, even when hot
- **Captive knobs and handles:** additional security when working at height or in transit
- **Access:** easy access to lamp house and lenses through top opening for fast and efficient maintenance
- **Easy access to all parts:** easy cleaning, re-lamping and maintenance
- **Specially designed handle:** for fast cable changing without having to go inside the unit
- **Safety grid:** earthed safety grid fitted as standard
- **Safety first:** front accessories safety cable attachment point

Picture:306L

DSEN003_306LPB - 23/03/2022

Robert Juliat reserves the right to change or alter any of the items detailed on this page, to increase or improve manufacturing techniques without prior notice.

Robert Juliat S.A.S., 32 rue de Beaumont, 60530 Fresnoy-en-Thelle - France
Telephone : +33 (0)3 44 26 51 89 - fax : +33 (0)3 44 26 90 79 - info@robertjuliat.fr
www.robertjuliat.com



ROBERT JULIAT

Source

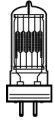

- **Lamp type:** Tungsten
- **Socket:** Gx9.5

Admissible lamps	Power *	Lumen output*	Colour temperature*	Life*
LIF: T19 (T11) - ANSI: FWP/FWR	1 000 W	21 000 lm	3050K	750 h
LIF: CP70 - ANSI: FVA/FVB	1 000 W	26 000 lm	3200K	200 h

(*) manufacturer's data

Optics

Characteristics

- **Type:** Single lens
- **Beam range:** 11° to 63°
- **Lens:** 150 mm Pebble lens

Gel filter

- **Shape:** Square
- **Standard size:** 180x180 mm (7.1x7.1")

Photometrics

with LIF: CP70 - ANSI: FVA/FVB source

• Optics @ 11°

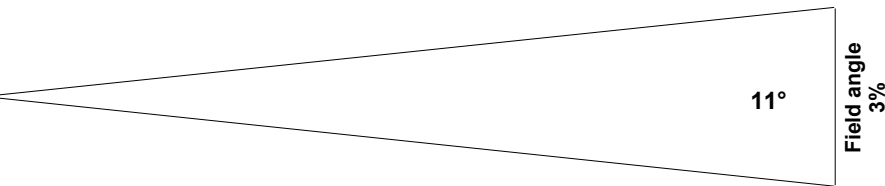
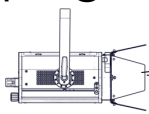

Beam intensity
156 000 cd

Distance	3 m	5 m	7 m	10 m	12 m	15 m
Diameter	0.6 m	1 m	1.3 m	1.9 m	2.3 m	2.9 m
Illumination	17 500 lux	6 300 lux	3 200 lux	1 600 lux	1 100 lux	700 lux
Distance	10 ft	15 ft	25 ft	35 ft	40 ft	50 ft
Diameter	1.9 ft	2.9 ft	4.8 ft	6.7 ft	7.7 ft	9.6 ft
Illumination	1 600 fc	700 fc	250 fc	130 fc	100 fc	65 fc

• Optics @ 63°

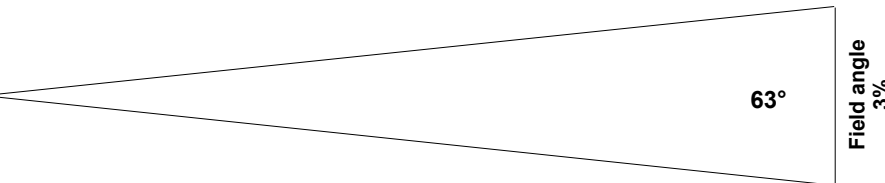
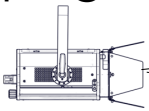

Beam intensity
8 700 cd

Distance	3 m	5 m	7 m	10 m	12 m	15 m
Diameter	3.7 m	6.1 m	8.6 m	12.3 m	14.7 m	18.4 m
Illumination	970 lux	350 lux	180 lux	90 lux	65 lux	39 lux
Distance	10 ft	15 ft	25 ft	35 ft	40 ft	50 ft
Diameter	12.3 ft	18.4 ft	30.6 ft	42.9 ft	49 ft	61.3 ft
Illumination	90 fc	39 fc	14 fc	8 fc	6 fc	4 fc

Dimensions and weight

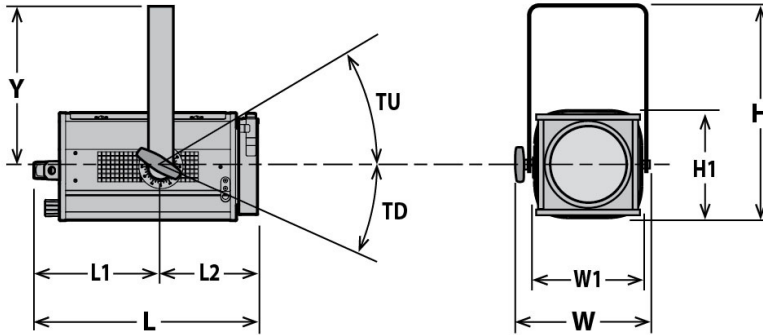

Weight: 7.2 kg (15.8 lbs)

Height	Length	Width	Yoke	Tilt
H= 385 mm (15.2 in) H1= 210 mm (8.3 in)	L= 430 mm (16.9 in) L1= 245 mm (9.6 in) L2= 185 mm (7.3 in)	W= 300 mm (11.8 in) W1= 208 mm (8.2 in)	Y= 290 mm (11.4 in)	TU= TBD° TD= TBD°

Shipping

- **Weight :** 8.4 kg (18.5 lbs)
- **Volume :** .04 m³ (1.41 ft³)

Installation

- **Minimum distance to illuminated surface:** 1.1 m (3.6 ft)
- **Operating position:**



Construction

- **Housing:** Steel sheet - Aluminium
- **Colour:** Black
- **Cooling:** Convection cooling
- **Maximum ambient temperature (Ta):** 40°C (104°F)
- **Maximum case temperature (Tc):** 240°C (464°F)
- **Total heat dissipation:** 3 413 BTU/h
- **Ingress Protection (IP) rating:** IP20

Electrical compatibility

- 230/240 V - 50 Hz
- ~~115/120 V - 60 Hz~~

Power input



- **Type:** attached power cord
- **Cable:** H07RNF 3G1.5
- **Length:** 3 m (9.8 ft)
- **Power connector:** CEE 7/7 (2P+E NF/Schuko)

Power consumption

Voltage	Frequency	Current	Power
230 V	50 Hz	5 A	1000 W

Warranty

- **Fixture: 2 years**
See General Sales Condition on website



Approvals















Model

306LPB	1000 W Tungsten Single lens luminaire - Gx9.5 socket - 150mm Pebble - 306LPB Lutin
---------------	------------------------------------------------------------------------------------

Options

CAV306E	Double slot front cassette for 185x185mm accessories	
PCP1716A	16A blue 2P+E 6h IEC60309 power connector	

Accessories

PF500M2	180x180mm metal filter holder 1 included	
G500	180x180mm safety grid 1 included	
CP70	CP70 - Gx9.5 1000W 230V 200h 3200K lamp	
T19 (T11)	T19 (T11) - Gx9.5 1000W 230V 750h 3050K lamp	
PF600M2	185x185mm metal filter holder	
CF500	4 rotating leaves on a rotating barndoor - 180x180mm (without safety cable) - Poids: 0.82 Kg	
L150 F	Ø150mm Fresnel lens with lens holder - Poids: 0.45 Kg	
L150 PC	Ø150mm Plano-convex lens with lens holder - Poids: 0.71 Kg	
TH600	180x180mm "Top hat" (without safety cable) - ø150mm / 150mm long	
876	Hook clamp 40x10mm with 28mm M10 screw for Ø35 to 50mm pipes - SWL: 50Kg - Poids: 1.25 Kg	
880	Hook clamp 40x10mm with 28mm M10 screw for Ø50 to 63mm pipes - SWL: 50Kg - Poids: 1.36 Kg	
CS2	Safety cable Ø3 mm L= 600mm - SWL: 75 Kg	
CS5	Safety cable Ø1,5 mm L=300mm for front accessory with karabiner and quick link - SWL: 25 Kg	