

# LUTIN - 306LF

306 - 1000 W TUNGSTEN



- **Type:** Single lens luminaire
- **Source:** 1000 W Tungsten
- **Optics:** 150 mm Fresnel lens

Single lens

## Compact 3-in-1 fixture

Lutin is a multi-purpose 1K Fresnel giving good general cover for smaller venues, schools and rental companies. Lenses can be quickly changed to PC or PB for extra versatility.

### Features

- **Theatre front cassette:** no light spill to distract audiences or performers
- **Colour runners:** double runners to hold accessories and colour filters
- **Barn door:** unique rotating barn door with 4 individually rotating blades – makes even the most difficult angle possible
- **Focus adjustment:** smooth focus adjustment from rear, even when lantern is hot, for a longer lamp life
- **Focus reference:** index for easy focus reference
- **Tilt reference on hanging yoke:** index for rapid re-positioning

### Optical

- **Choice of 3 lenses:** fresnel, Plano-Convex & Pebble-Convex – no tools required
- **A clean beam:** paint and light traps to avoid light leaks

### Construction

- **Made in France :** fully manufactured in Robert Juliat premises retaining complete control over all aspects of quality
- **Air vents:** efficient cooling with no light spill
- **Bodywork:** strong sheet metal construction for durability
- **Internal cable guide:** to prevent cables from becoming entangled in movable lamp tray
- **Moving parts:** smooth at all times, even when hot
- **Captive knobs and handles:** additional security when working at height or in transit
- **Access:** easy access to lamp house and lenses through top opening for fast and efficient maintenance
- **Easy access to all parts:** easy cleaning, re-lamping and maintenance
- **Specially designed handle:** for fast cable changing without having to go inside the unit
- **Safety grid:** earthed safety grid fitted as standard
- **Safety first:** front accessories safety cable attachment point

Picture:306L

DSEN002\_306LF - 23/03/2022

Robert Juliat reserves the right to change or alter any of the items detailed on this page, to increase or improve manufacturing techniques without prior notice.

Robert Juliat S.A.S., 32 rue de Beaumont, 60530 Fresnoy-en-Thelle - France  
Telephone : +33 (0)3 44 26 51 89 - fax : +33 (0)3 44 26 90 79 - info@robertjuliat.fr  
www.robertjuliat.com



ROBERT JULIAT

## Source

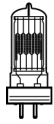

- **Lamp type:** Tungsten
- **Socket:** Gx9.5

Admissible lamps	Power *	Lumen output*	Colour temperature*	Life*
LIF: T19 (T11) - ANSI: FWP/FWR	1 000 W	21 000 lm	3050K	750 h
LIF: CP70 - ANSI: FVA/FVB	1 000 W	26 000 lm	3200K	200 h

(\*) manufacturer's data

## Optics

### Characteristics

- **Type:** Single lens
- **Beam range:** 6° to 45°
- **Lens:** 150 mm Fresnel lens

### Gel filter

- **Shape:** Square
- **Standard size:** 180x180 mm (7.1x7.1")

## Photometrics

with LIF: CP70 - ANSI: FVA/FVB source

### • Optics @ 6°

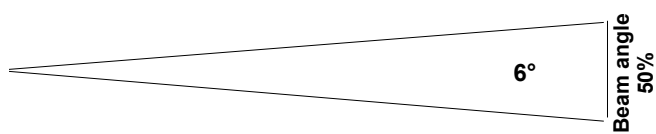
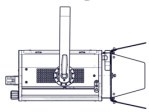

**Beam intensity**  
105 000 cd

<b>Distance</b>	3 m	5 m	7 m	10 m	12 m	15 m
<b>Diameter</b>	0.3 m	0.5 m	0.7 m	1 m	1.3 m	1.6 m
<b>Illumination</b>	12 000 lux	4 250 lux	2 150 lux	1 100 lux	730 lux	470 lux
<b>Distance</b>	10 ft	15 ft	25 ft	35 ft	40 ft	50 ft
<b>Diameter</b>	1 ft	1.6 ft	2.6 ft	3.7 ft	4.2 ft	5.2 ft
<b>Illumination</b>	1 100 fc	470 fc	170 fc	90 fc	70 fc	43 fc

### • Optics @ 45°

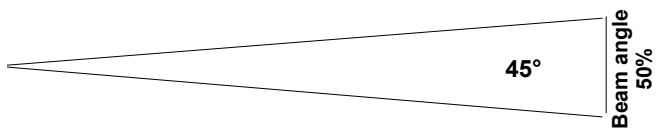
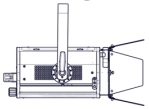

**Beam intensity**  
17 000 cd

<b>Distance</b>	3 m	5 m	7 m	10 m	12 m	15 m
<b>Diameter</b>	2.5 m	4.1 m	5.8 m	8.3 m	9.9 m	12.4 m
<b>Illumination</b>	1 900 lux	690 lux	350 lux	180 lux	120 lux	80 lux
<b>Distance</b>	10 ft	15 ft	25 ft	35 ft	40 ft	50 ft
<b>Diameter</b>	8.3 ft	12.4 ft	20.7 ft	29 ft	33.1 ft	41.4 ft
<b>Illumination</b>	180 fc	80 fc	28 fc	14 fc	11 fc	7 fc

## Dimensions and weight

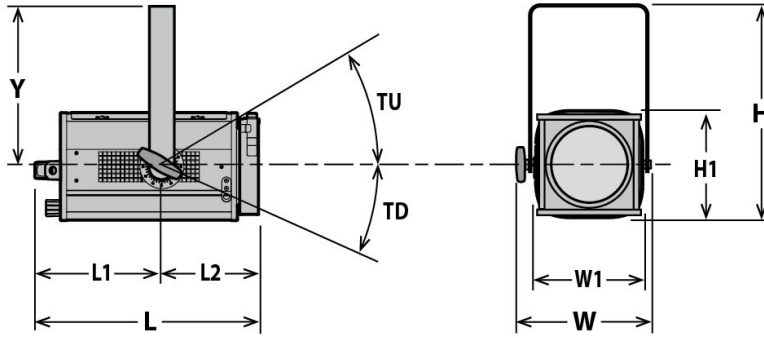

**Weight:** 7.2 kg (15.8 lbs)

Height	Length	Width	Yoke	Tilt
H= 385 mm (15.2 in) H1= 210 mm (8.3 in)	L= 430 mm (16.9 in) L1= 245 mm (9.6 in) L2= 185 mm (7.3 in)	W= 300 mm (11.8 in) W1= 208 mm (8.2 in)	Y= 290 mm (11.4 in)	TU= TBD° TD= TBD°

## Shipping

- **Weight :** 7.8 kg (17.2 lbs)
- **Volume :** .04 m<sup>3</sup> (1.41 ft<sup>3</sup>)

## Installation

- **Minimum distance to illuminated surface:** 1.1 m ( 3.6 ft )
- **Operating position:**



## Construction

- **Housing:** Steel sheet - Aluminium
- **Colour:** Black
- **Cooling:** Convection cooling
- **Maximum ambient temperature (Ta):** 40°C (104°F)
- **Maximum case temperature (Tc):** 240°C (464°F)
- **Total heat dissipation:** 3 413 BTU/h
- **Ingress Protection (IP) rating:** IP20

## Electrical compatibility

- 230/240 V - 50 Hz
- ~~115/120 V - 60 Hz~~

## Power input



- **Type:** attached power cord
- **Cable:** H07RNF 3G1.5
- **Length:** 3 m (9.8 ft)
- **Power connector:** CEE 7/7 (2P+E NF/Schuko)

## Power consumption

Voltage	Frequency	Current	Power
230 V	50 Hz	5 A	1000 W

## Warranty

- **Fixture: 2 years**  
See General Sales Condition on website



## Approvals















## Model

<b>306LF</b>	1000 W Tungsten Single lens luminaire - Gx9.5 socket - 150mm Fresnel - 306LF Lutin
--------------	--

## Options

<b>CAV306E</b>	Double slot front cassette for 185x185mm accessories	
<b>PCP1716A</b>	16A blue 2P+E 6h IEC60309 power connector	

## Accessories

<b>PF500M2</b>	180x180mm metal filter holder <b>1 included</b>	
<b>G500</b>	180x180mm safety grid <b>1 included</b>	
<b>CP70</b>	CP70 - Gx9.5 1000W 230V 200h 3200K lamp	
<b>T19 (T11)</b>	T19 (T11) - Gx9.5 1000W 230V 750h 3050K lamp	
<b>PF600M2</b>	185x185mm metal filter holder	
<b>CF500</b>	4 rotating leaves on a rotating barndoor - 180x180mm ( without safety cable) - Poids: 0.82 Kg	
<b>L150 PB</b>	Ø150mm Pebble convex lens with lens holder - Poids: 0.84 Kg	
<b>L150 PC</b>	Ø150mm Plano-convex lens with lens holder - Poids: 0.71 Kg	
<b>TH600</b>	180x180mm "Top hat" (without safety cable) - ø150mm / 150mm long	
<b>876</b>	Hook clamp 40x10mm with 28mm M10 screw for Ø35 to 50mm pipes - SWL: 50Kg - Poids: 1.25 Kg	
<b>880</b>	Hook clamp 40x10mm with 28mm M10 screw for Ø50 to 63mm pipes - SWL: 50Kg - Poids: 1.36 Kg	
<b>CS2</b>	Safety cable Ø3 mm L= 600mm - SWL: 75 Kg	
<b>CS5</b>	Safety cable Ø1,5 mm L=300mm for front accessory with karabiner and quick link - SWL: 25 Kg	