

# DALIS - 861

PROJECTEUR WASH ASYMÉTRIQUE  
ASYMMETRIC WASHLIGHT

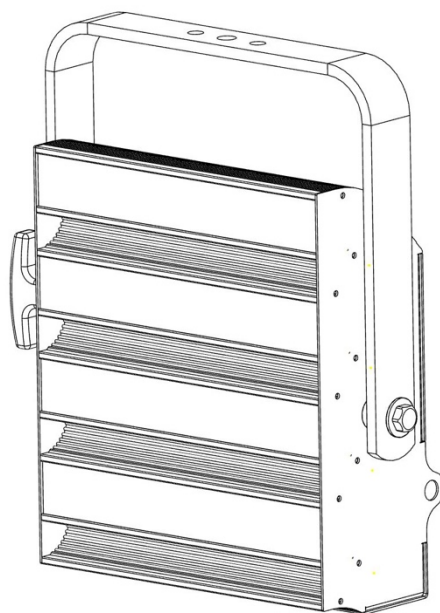

*PROJECTEUR WASH ASYMÉTRIQUE 150W LED 8 COULEURS  
8 COLOURS LED 150W ASYMMETRIC WASHLIGHT*

DALIS - 861  
Software version V1.XX – 27/03/17

DN41108200



**ROBERT JULIAT**

## Table of contents

1	User's instructions .....	1
2	Presentation .....	2
2.1	Functions .....	2
2.2	Identification plate .....	2
2.3	Accessories included .....	3
2.4	Optional accessories .....	3
3	Set-up .....	4
3.1	Mechanics .....	4
3.2	Electrical .....	6
3.3	DATA .....	7
4	Operation .....	9
4.1	Light intensity .....	9
4.2	Colours .....	10
4.3	Colour presets .....	12
4.4	CCT .....	14
4.5	Strobe .....	14
4.6	Response time .....	15
5	Control and parameters .....	16
5.1	Local display and Controls .....	16
5.2	DMX512-A remote control .....	18
5.3	RDM remote control .....	22
5.4	Art-Net remote control .....	23
5.5	sACN remote control .....	24
6	Service .....	25
6.1	Preventive maintenance .....	25
6.2	Analysis .....	25
6.3	Electronic thermal management system .....	25
6.4	Firmware update .....	25
6.5	Factory defaults .....	25

# 1 User's instructions

## GENERAL INSTRUCTIONS

1. Not for residential use.
2. **These fixtures must only be serviced by a qualified technician.**
3. In addition to the instructions indicated on this page, relevant health and safety requirements of the appropriate EU Directives must be adhered to at all times.
4. This fixture is in compliance with section 17 - Lighting appliance for theatre stages, television, cinema and photograph studios. Standards NF EN 60598-1 and NF EN 60598-2-17.
5. This fixture is rated as IP20, and is for indoor use only.

## FIXTURE

6. Ensure fixture is correctly mounted on an appropriate support.
7. Protection screens must be replaced in the event of any damage, such as cracks or deep scratches, since these might reduce performance.
8. When hung or flown the fixture must be secured by an additional hanging accessory (such as a safety cable or bond) of suitable length.
9. Safety bonds or cables must be securely attached to the fixture and be as short as possible, or rolled up as necessary, to minimise travel distance should the fixture be dislodged.
10. **WARNING:** LED source become hot during use. Allow fixture to cool before servicing.
11. Do not tamper with design of fixture nor any of its safety features.
12. Tighten electrical mains cable connections regularly and replace with one of identical specification if damaged.
13. Use only with correct power supply.
14. Do not orientate the fixture towards a source of light (sun, fixture), in particular for LED versions.

## VENTILATION

15. Keep well away from flammable material.
16. Not for outdoor use. Do not cover. Do not permit fixture to get wet.
17. To avoid overheating, do not obstruct air vents – **do not cover the unit.**

## PLEASE NOTE

These products have been built to conform to European standards relating to professional lighting equipment. Any modification made to our products will void the manufacturers' warranty.

### Photobiological safety according to EN62471

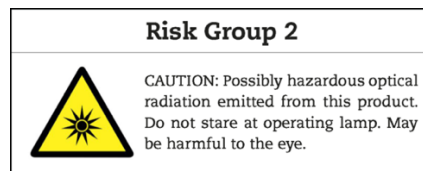
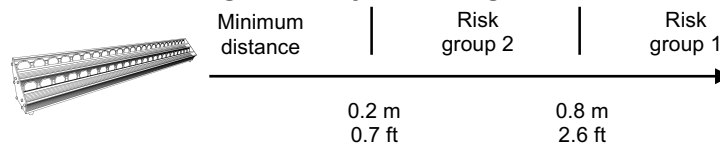

## 2 Presentation

### 2.1 Functions

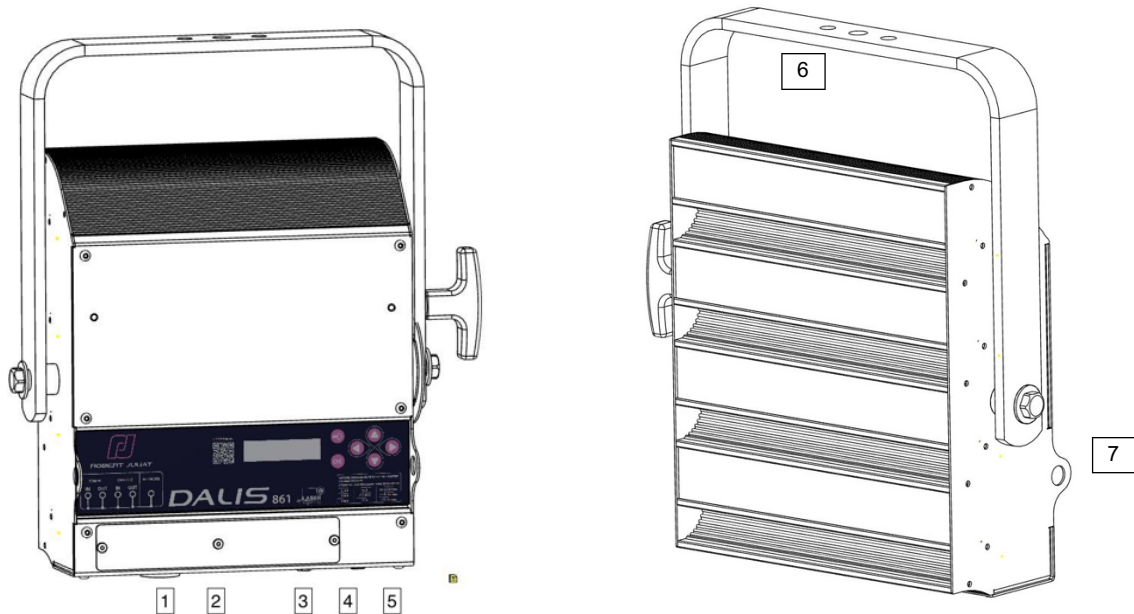

#### Functions :

- |   |   |
|---|---|
| <ol style="list-style-type: none"> <li>1. Power input</li> <li>2. Power output</li> <li>3. Data IN</li> <li>4. Data Out</li> <li>5. Ethernet</li> </ol> | <ol style="list-style-type: none"> <li>6. Yoke</li> <li>7. Safety cable attachment point</li> </ol> |
|---|---|

### 2.2 Identification plate

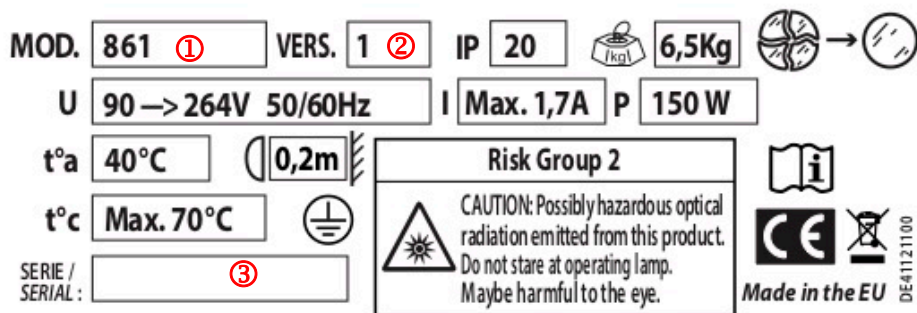

(4)

#### Description :

- |   |  |
|---|--|
| <ol style="list-style-type: none"> <li>1. Model :</li> <li>2. Version (Hardware version)</li> </ol> | <ol style="list-style-type: none"> <li>3. Serial number</li> <li>4. Serial number in barcode format</li> </ol> |
|---|--|

### 2.3 Accessories included

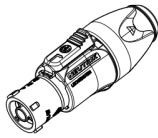

①

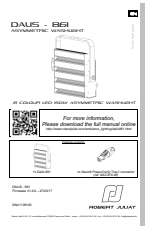

②

	Reference	Description
1	COU0003305	Neutrik PowerCon® True1 connector (ref. NAC3FX-W)
2	DN41081000	Quick Start manual

### 2.4 Optional accessories

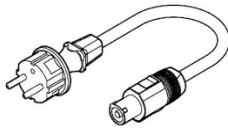

①

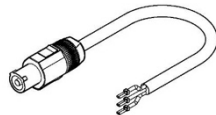

②

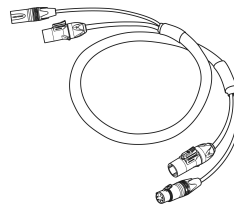

③



④



⑤



⑥



⑦

⑧

	Reference	Description
1	<b>CAL03</b>	3 meter power cable ( 3G1,5 HO7RNF) with Neutrik PowerCon® True1 and CEE 7/7 (2P+T NF/SCHUKO) connectors
2	<b>CAL04</b>	1,50m power cable UL/CSA with Neutrik PowerCon® connector
3	<b>CAL05</b>	Combined Neutrik PowerCon® True1 / DMX (5 pins) patch cable - length: 1m
4	<b>CS2</b>	Safety cable Ø3 mm L= 600mm - SWL: 75 Kg
5	<b>872</b>	Doughty "Twenty clamp" with M10 screw/nut for Ø48 to 51mm pipes - SWL: 20Kg - TÜV approved
6	<b>876</b>	Hook clamp 40x10mm with 28mm M10 screw for Ø35 to 50mm pipes - SWL: 50Kg
7	<b>880</b>	Hook clamp 40x10mm with 28mm M10 screw for Ø50 to 63mm pipes - SWL: 50Kg
8		

### 3 Set-up

#### 3.1 Mechanics

##### 3.1.1 Operating positions

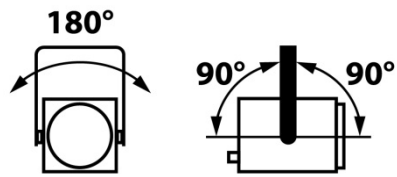

##### 3.1.2 Minimum distance between a flammable material and the lighting unit

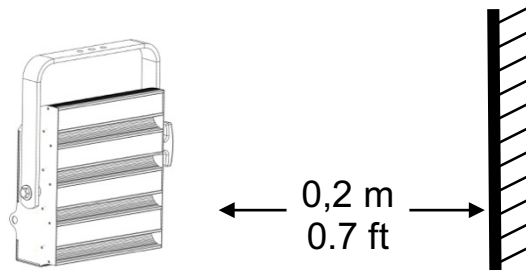

##### 3.1.3 Instructions for use

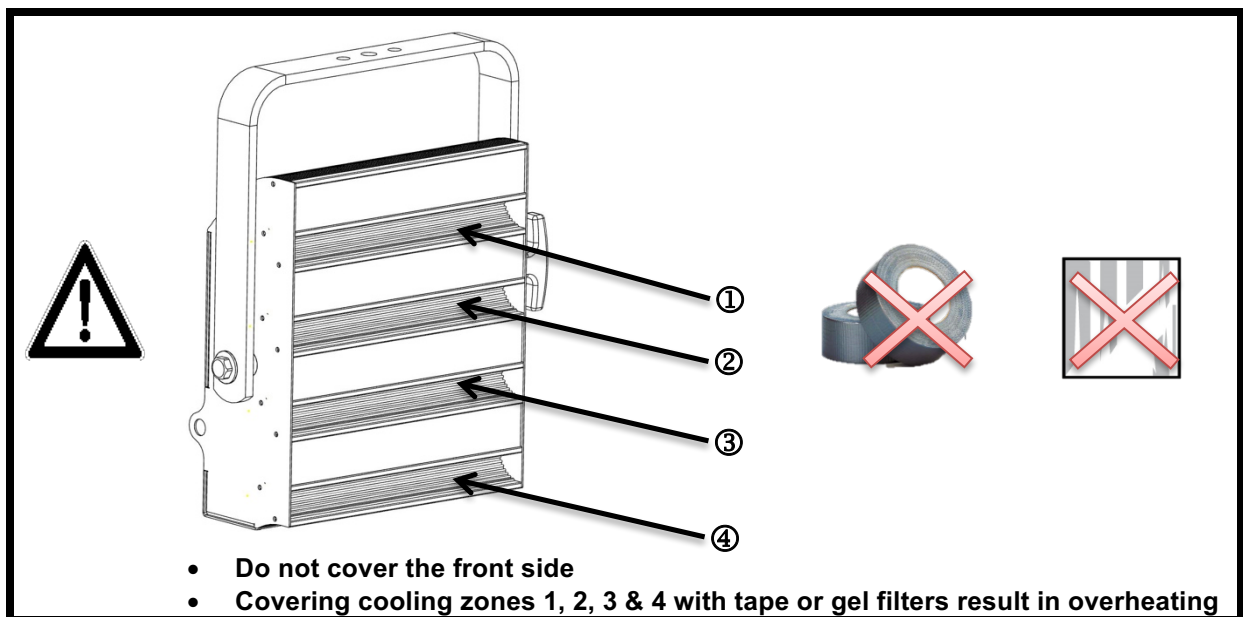
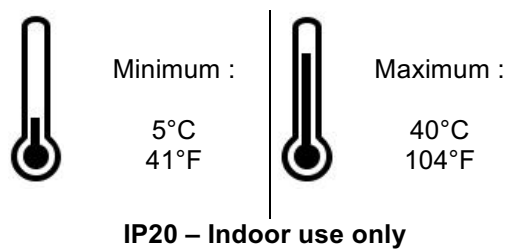

### 3.1.4 Installation

- Ensure fixture is correctly mounted on an appropriate support.
- **The fixture must be installed with a clamp.**
- Net weight : 6,5 Kgs

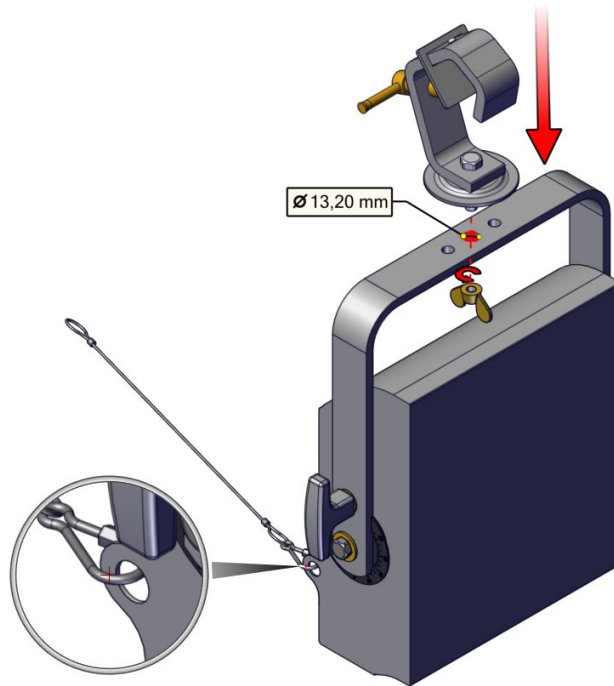

### 3.1.5 Safety cable

- When hung or flown, the fixture must be secured by an additional hanging accessory (such as safety bond or cable) of suitable length.
- Safety cables or bonds must be securely attached to the back of the fixture (Ⓢ attachment point) and be as short as possible, or rolled up as necessary, to minimise travel distance should the fixture be dislodged.

### 3.1.6 Angular sensor

→ selection in *STATUS/ANGULAR ADJUSTMENT* menu

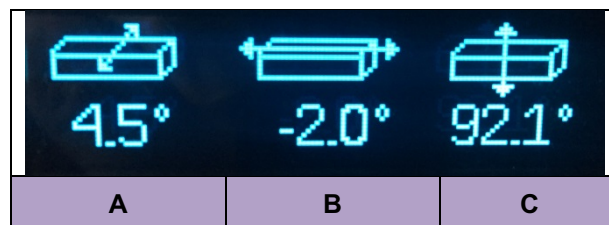

### 3.2 Electrical

#### 3.2.1 Power

Voltage	Frequency	Input power	Connectors
90 → 265 V	50-60 Hz	0.8 A / 141 W @ 230V 1.3 A / 143 W @ 120V 1.5 A / 142 W @ 100V Max. 1.7 A	Neutrik powerCON TRUE1 ref. NAC3FPX (max. 20A) <b>see appendix 1 for assembly instructions</b>



- Class 1 product. **This luminaire must be grounded.**
- Must be connected directly to AC power. **Do not connect to dimmer power.**
- Automatic power detection.
- **Daisy chain: maximum of 20 units (230V) / 10 units (120V) / 8 units (100V)**

**Daisy chain** (with optional patch cable):

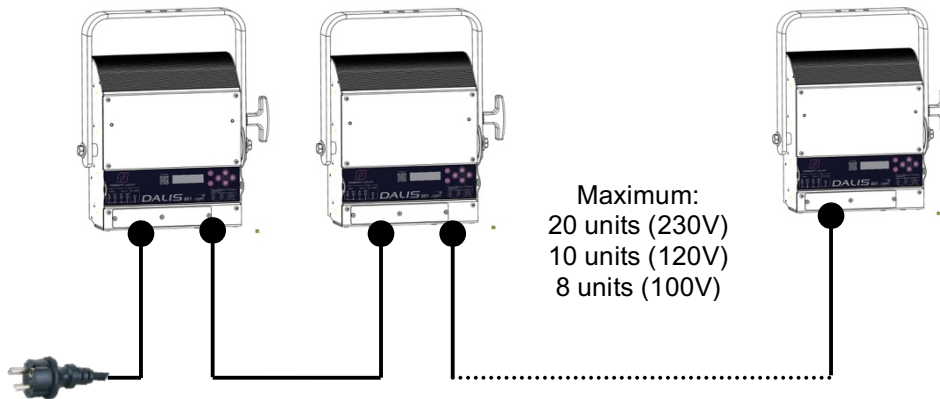

#### 3.2.2 Power cable

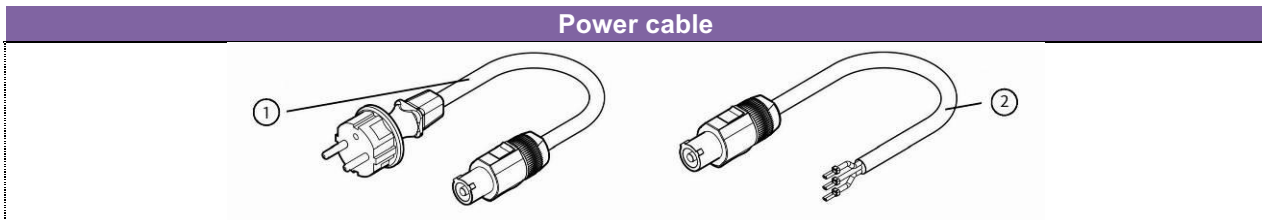

Power cable		Connector	Mains plug	Cable type	Cable length	Wiring
1	Standard version	Neutrik PowerCon® NAC3FX	CEE7/7	3G1.5 H07RNF	3 m 9.8 ft	Live: Brown Neutral: Blue Ground: Yellow/Green
2	North American version		-	14AWG SJ TYPE (UL/CSA)	1.5 m 4.9 ft	Live: Black Neutral: White Ground: Green

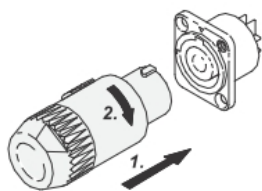

In

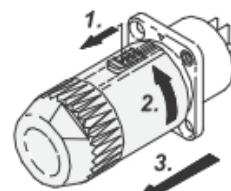

Out



### 3.3 DATA

#### 3.3.1 DMX 512-A / RDM

Protocol	Input connector	Output connector
USITT DMX 512-A RDM	XLR 5-pin	XLR 5-pin

DATA connectors		
PIN #	DMX	Description
1	Shielding	Foil & Braided Shield
2	DMX (-)	1 <sup>st</sup> conductor of 1 <sup>st</sup> twisted pair
3	DMX (+)	2 <sup>nd</sup> conductor of 1 <sup>st</sup> twisted pair
4	Not used	1 <sup>st</sup> conductor of 2 <sup>nd</sup> twisted pair
5	Not used	2 <sup>nd</sup> conductor of 2 <sup>nd</sup> twisted pair

DMX OUT      DMX IN

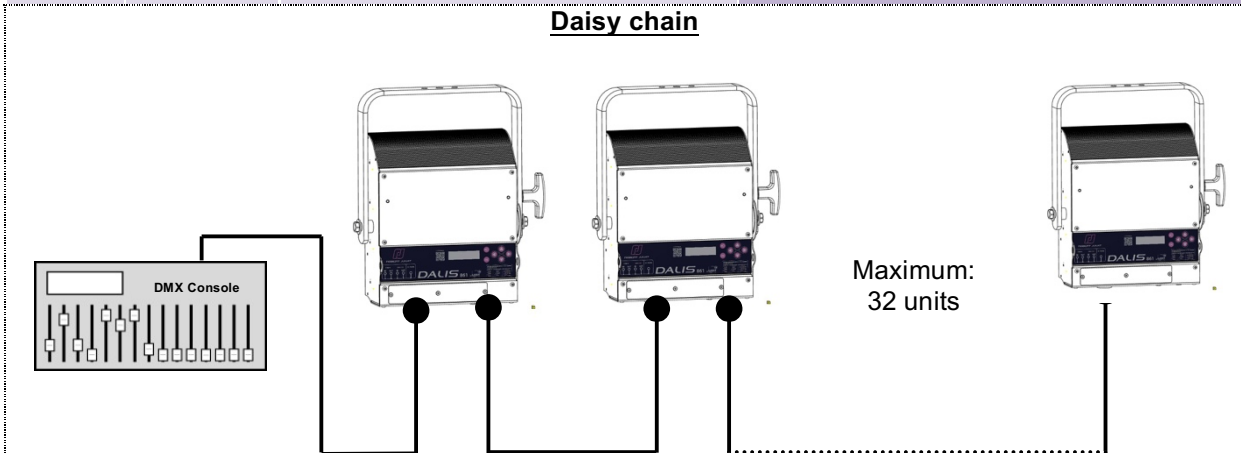

#### 3.3.2 Art-Net / sACN

Protocol	Input connector	Output connector
Art-Net sACN	RJ45	-

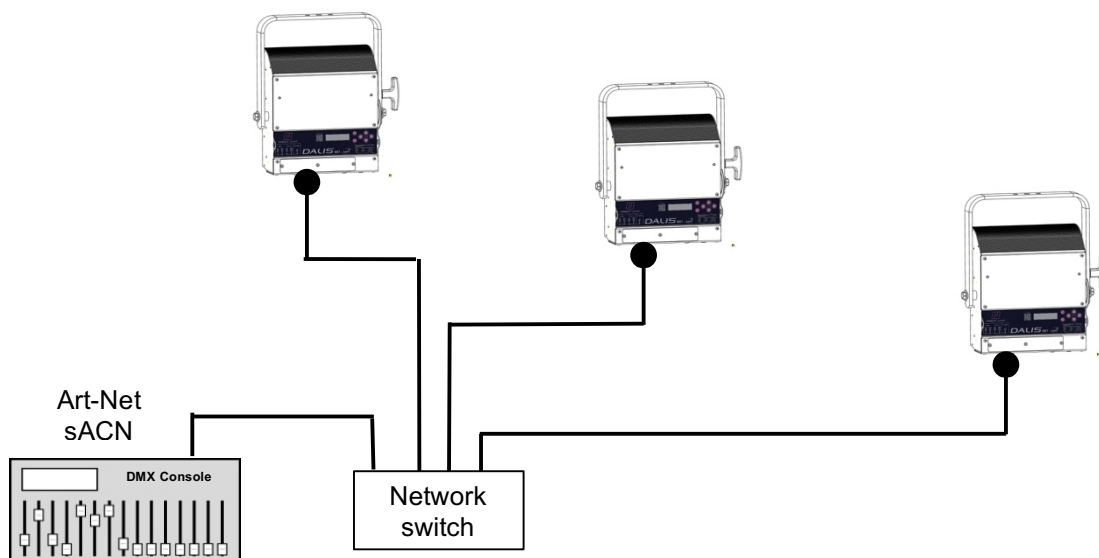

### 3.3.3 Ethernet/DMX node

Protocol	Input connector	Output connector
Art-Net sACN	RJ45	DMX

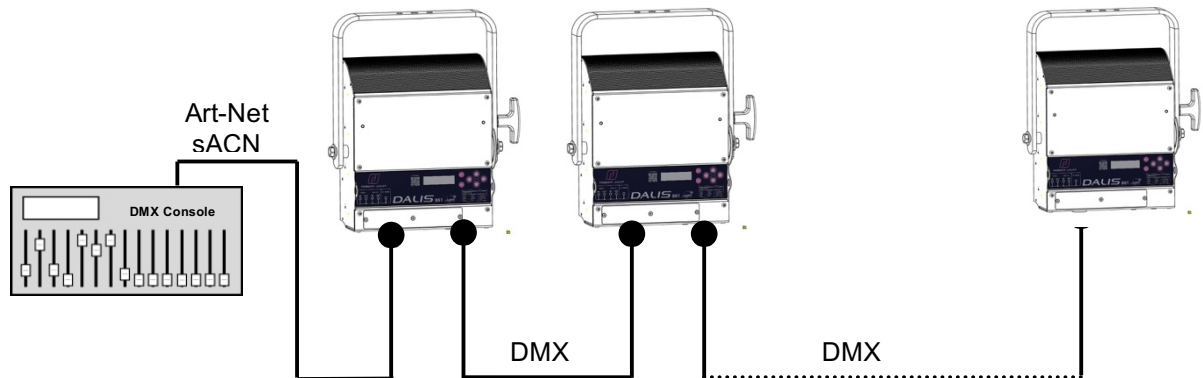

## 4 Operation

### 4.1 Light intensity

#### 4.1.1 Range



#### 4.1.2 Control

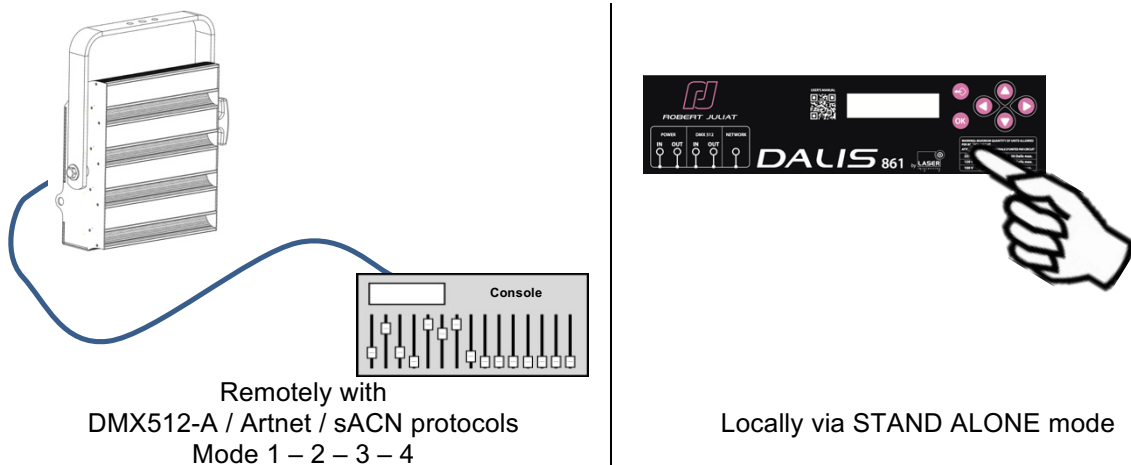

#### 4.1.3 Parameters

##### 4.1.3.1 Dimming resolution

Resolution	DMX mode :
8 bits – 255 steps	4 – STAND ALONE
16 bits – 65 535 steps	1 – 2 – 3

##### 4.1.3.2 Dimming curve

→ selection in *SETUP/DIMMER CURVE* menu: Linear or Square

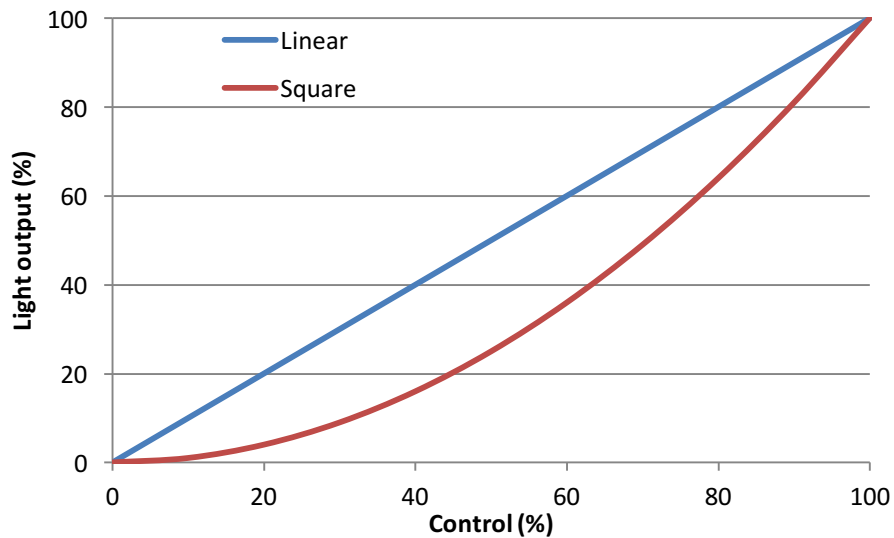

## 4.2 Colours

### 4.2.1 Range

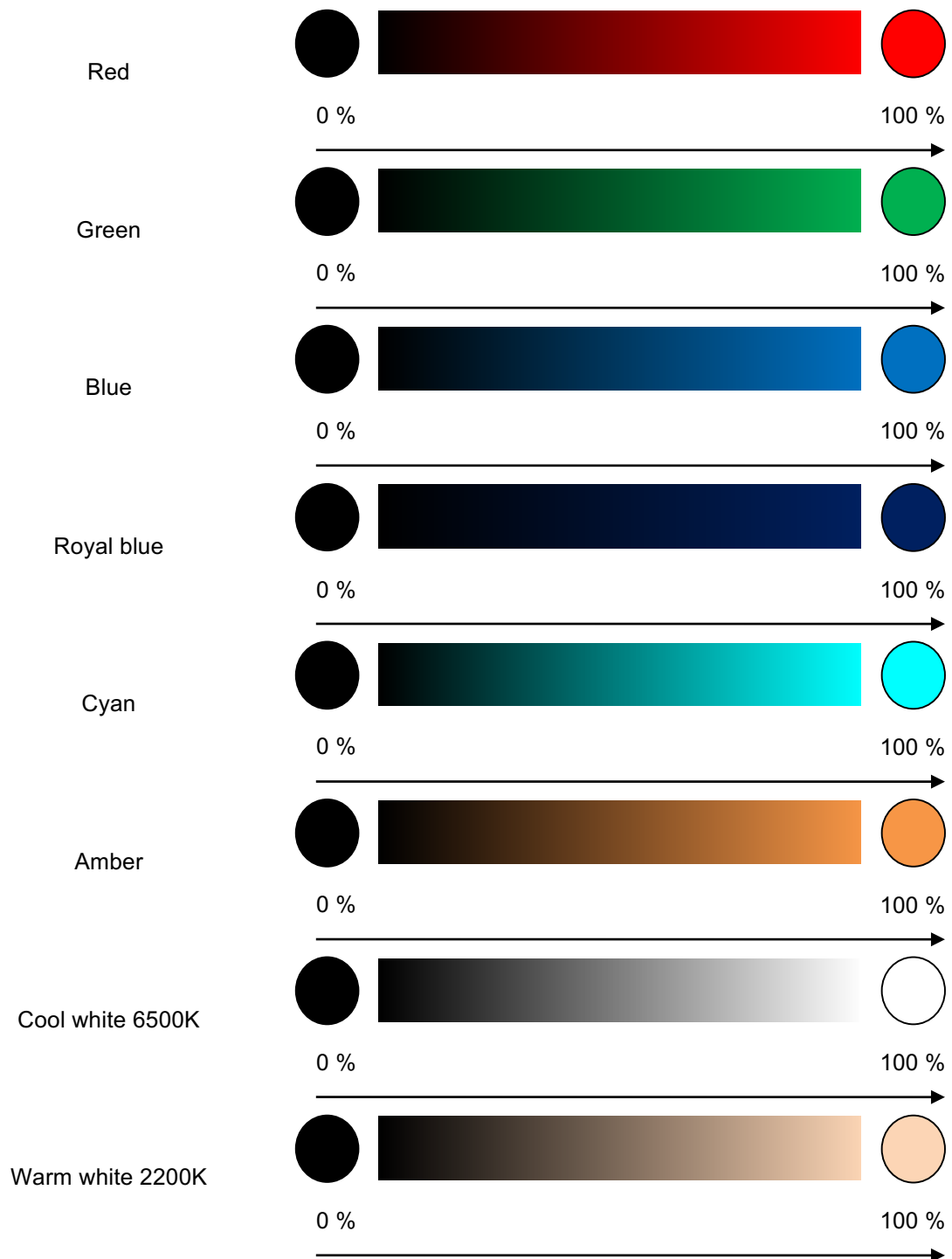

#### 4.2.2 Control

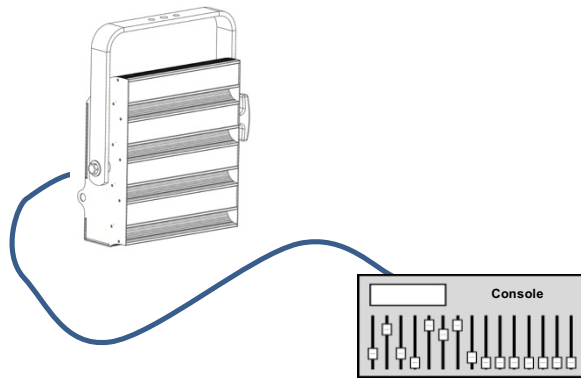

Remotely with  
DMX512-A / Art-Net / sACN protocols  
Mode 1 – 2

#### 4.2.3 Parameters

##### 4.2.3.1 Resolution

Resolution	DMX mode :
8 bits – 255 steps	2
16 bits – 65 535 steps	1

##### 4.2.3.2 Intensity curve

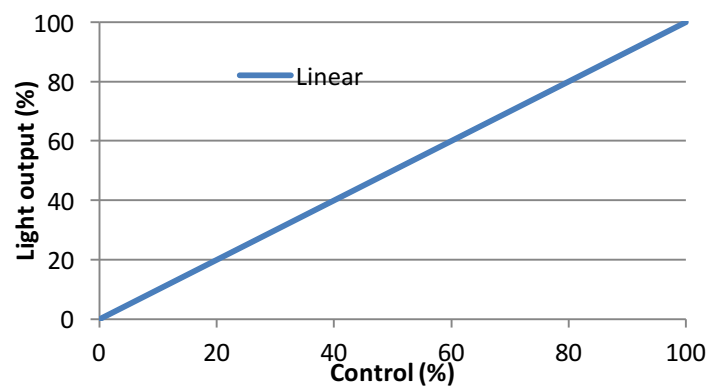

##### 4.2.3.3 Cyan correction

→ selection in *SETUP/CYAN CORRECTION* menu: OFF or ON

Correction	Colour compatibility		
OFF	<p>Dalis 861</p>	<p>≠</p> <p>Cyan colour is slightly different</p>	<p>Dalis 860 hardware V1</p>
ON	<p>Dalis 861</p>	<p>=</p> <p>Identical colours Cyan correction function must be activated on both units</p>	<p>Dalis 860 hardware V1</p>

### 4.3 Colour presets

#### 4.3.1 Range

→ Each preset has been calibrated by comparison with 1000W tungsten cyclight.

#	Gel reference*
1	L203: 1/4 CTB (E-color 203)
2	L202: 1/2 CTB (E-color 202)
3	L201: Full CTB (E-color 201)
4	L200: Double CTB (E-color 200)
5	L204: Full CTO (E-color 204)
6	L205: Half CTO (E-color 205)
7	E-Color 242: Fluorescent 4300K (L242 Fluorescent 4300K)
8	E-Color 241: Fluorescent 5700K (L241 Fluorescent 5700K)
9	E-Color 174: Dark steel blue (L161 Slate blue)
10	E-Color 161: Slate blue (L161 Slate blue)
11	E-Color 165: Daylight blue (L165 Daylight blue)
12	E-Color 353: Lighter blue (L353 Lighter blue)
13	Supergel 68: Parry sky blue (L68 Sky blue)
14	Supergel 79: Bright blue (L79 Just blue)
15	Supergel 82: Surprise blue (L723 Surprise blue)
16	E-Color 119: Dark blue (L119 Dark blue)
17	E-Color 363: Special medium blue (L363 Special medium blue)
18	E-Color 122: Fern green (L122 Fern green)
19	E-Color 124: Dark green (L124 Dark green)
20	E-Color 138: Pale green (L138 Pale green)
21	E-Color 134: Golden amber (L134 Golden amber)
22	E-Color 147: Apricot (L147 Apricot)
23	E-Color 101: Yellow (L101 yellow)
24	E-Color 105: Orange (L105 orange)
25	E-Color 344: Violet (L328 Follies pink)
26	E-Color 180: Dark lavender (L706 King fals lavender)
27	E-Color 106: Primary red (L182 Light red)
28	White : 6500 Kelvin
29	White : 6000 Kelvin
30	White : 5600 Kelvin
31	White : 4200 Kelvin
32	White : 4000 Kelvin
33	White : 3500 Kelvin
34	White : 3200 Kelvin
35	White : 3000 Kelvin
36	White : 2700 Kelvin
37	White : 2200 Kelvin

\*L = Lee Filter

E-color = Rosco E-color

Supergel = Rosco Supergel

### 4.3.2 Control

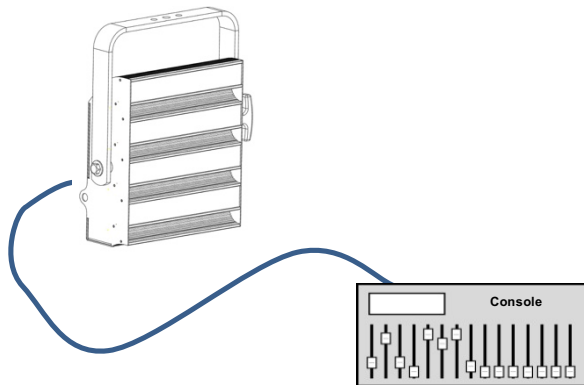

Remotely with  
DMX512-A / Art-Net / sACN protocols  
Mode 3 – 4



Locally via STAND ALONE mode

### 4.3.3 Parameters

#### 4.3.3.1 Resolution

Resolution	DMX mode :
8 bits – 255 steps	4
16 bits – 65 535 steps	3 – STAND ALONE

#### 4.3.3.2 Cyan correction

→ selection in *SETUP/CYAN CORRECTION* menu: OFF or ON

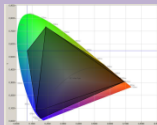
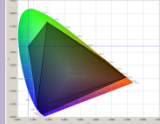
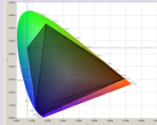
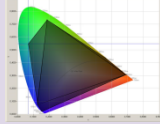
Correction	Colour compatibility		
OFF	 Dalis 861	$\neq$ Cyan colour is slightly different	 Dalis 860 hardware V1
ON	 Dalis 861	$=$ Identical colours Cyan correction function must be activated on both units	 Dalis 860 hardware V1

#### 4.4 CCT

##### 4.4.1 Range



##### 4.4.2 Control

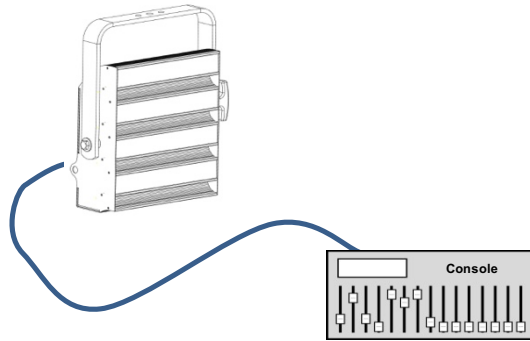

Remotely with  
DMX512-A / Art-Net / sACN protocols  
Mode 3 – 4

#### 4.5 Strobe

##### 4.5.1 Range

Strobe duration



Strobe speed

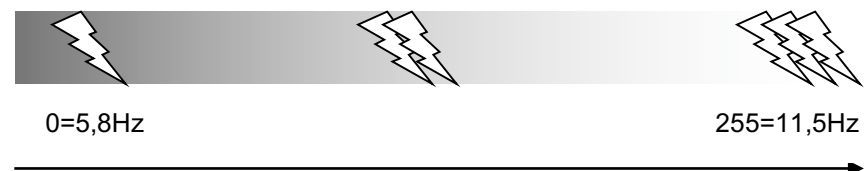

##### 4.5.2 Control

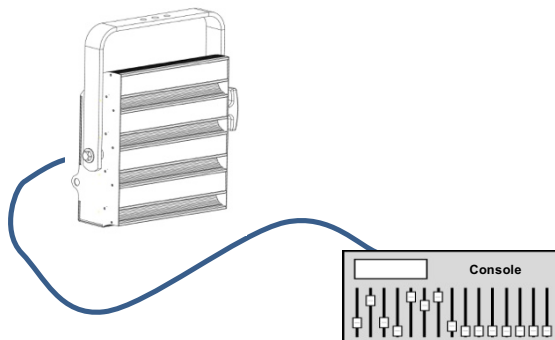

Remotely with  
DMX512-A / Art-Net / sACN protocols  
Mode 1 – 2 – 3 – 4



## 4.6 Response time

### 4.6.1 Range



### 4.6.2 Control

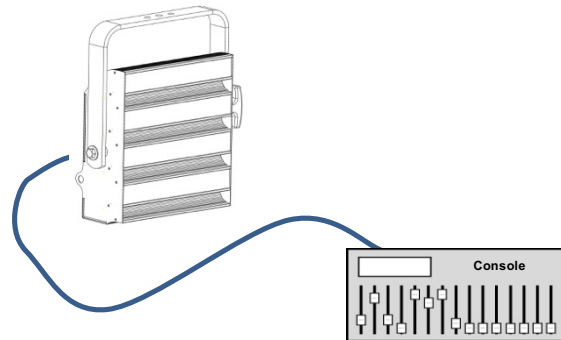

Remotely with  
DMX512-A / Art-Net / sACN protocols  
Mode 1 – 2 – 3 – 4

## 5 Control and parameters

### 5.1 Local display and Controls

#### 5.1.1 Display



	Function
	Exit the current menu option and/or go back
	Enter the current menu option and/or valid
	Scrolls through menus and/or Increase data value
	Scrolls through menus and/or Decrease data value
	Scrolls through menus and/or Increase data value
	Scrolls through menus and/or Decrease data value

#### 5.1.2 Parameters

##### 5.1.2.1 Display mode

→ Selection in *SETUP/DISPLAY MODE* menu

Display	Mode	Description
	Auto-OFF	Main display OFF after 20 seconds
	Always on	Main display always ON
	DATA check (dot)	Main display OFF – only a “dot” sign is visible if data detected

##### 5.1.2.2 Display flip

→ Selection in *SETUP/DISPLAY FLIP* menu

Display	Mode	Description
	Auto	Auto-flip of the display
	Normal	Display in normal position
	Flip	Display reversed

##### 5.1.2.3 Display faults

→ Selection in *SETUP/DISPLAY FAULTS* menu

Display	Mode	Description
	Warn on faults	Message displayed in case of data error
	Don't warn on faults	No message in case of data error – display remains the same

### 5.1.3 Menus

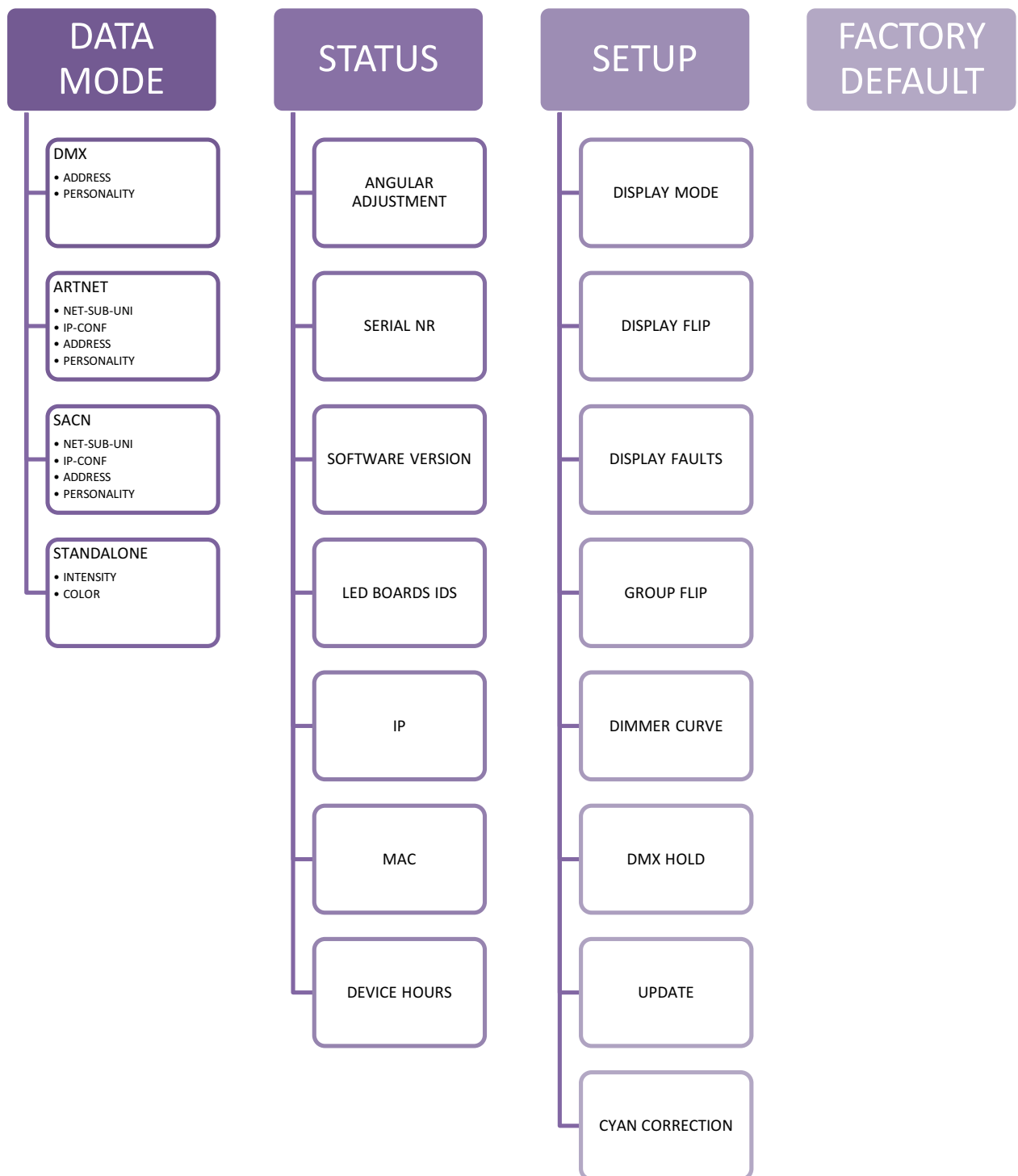

## 5.2 DMX512-A remote control

### 5.2.1 Protocol:

E1.11 – 2008, USITT DMX512-A

### 5.2.2 Configuration:

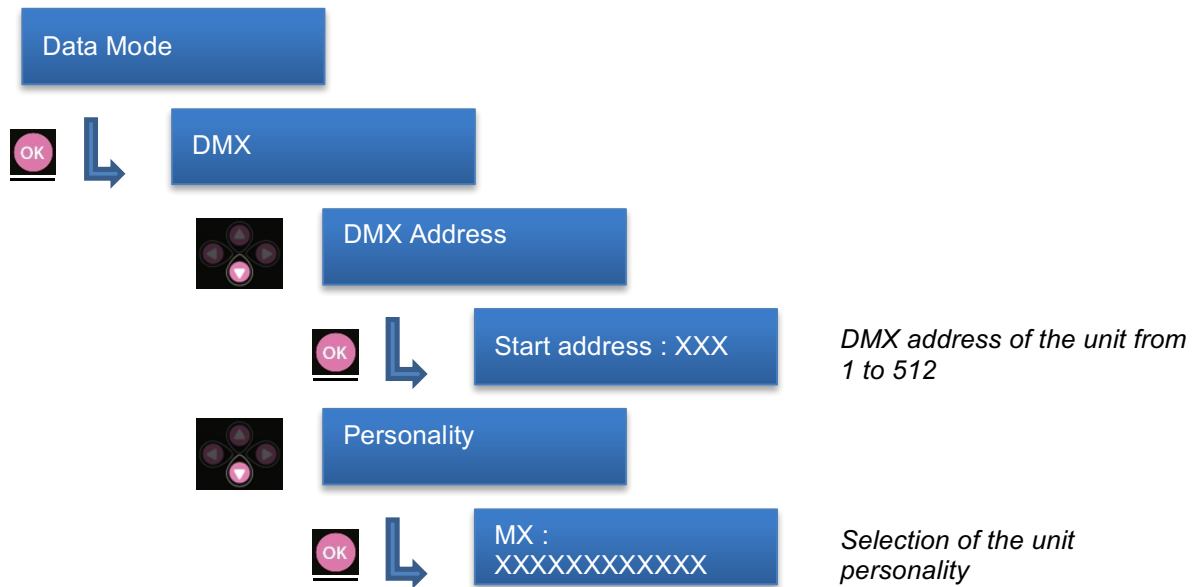

### 5.2.3 Parameters

#### 5.2.3.1 DMX Hold

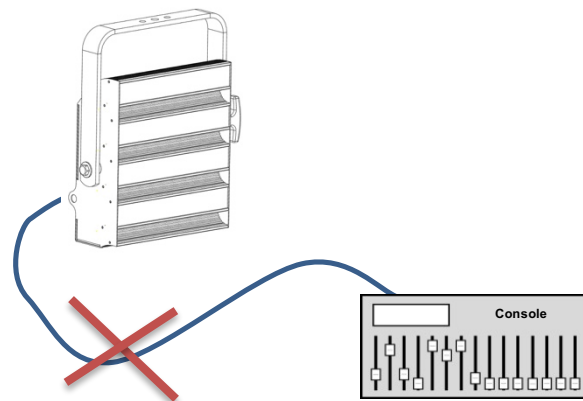

→ Selection in *SETUP/DMX HOLD* menu

**If data not detected**

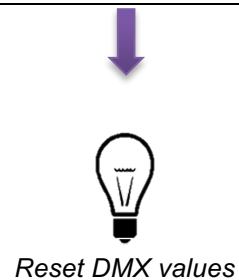

#### 5.2.4 DMX chart:

DMX address	Mode 1: FullMode16b	Mode 2: FullMode8b	Mode 3: Presetmode16b	Mode 4 Presetmode8b
1	Dimmer	Dimmer	Dimmer	Dimmer
2	Dimmer fine	Red	Dimmer fine	Colour presets
3	Red	Green	Colour presets	CCT
4	Red fine	Blue	CCT	Strobe duration
5	Green	Royal blue	Strobe duration	Strobe speed
6	Green fine	Cyan	Strobe speed	Response time
7	Blue	Amber	Response time	Control mode
8	Blue fine	Cool white	Control mode	
9	Royal blue	Warm white		
10	Royal blue fine	Strobe duration		
11	Cyan	Strobe speed		
12	Cyan fine	Response time		
13	Amber	Control mode		
14	Amber fine			
15	Cool white			
16	Cool white fine			
17	Warm white			
18	Warm white fine			
19	Strobe duration			
20	Strobe speed			
21	Response time			
22	Control mode			

## 5.2.5 DMX ranges:

### 5.2.5.1 Colour presets

Range min	Range max	Description
0	4	-
5	9	L203: 1/4 CTB (E-color 203)
10	14	L202: 1/2 CTB (E-color 202)
15	19	L201: Full CTB (E-color 201)
20	24	L200: Double CTB (E-color 200)
25	29	L204: Full CTO (E-color 204)
30	34	L205: Half CTO (E-color 205)
35	39	E-Color 242: Fluorescent 4300K (L242 Fluorescent 4300K)
40	44	E-Color 241: Fluorescent 5700K (L241 Fluorescent 5700K)
45	49	E-Color 174: Dark steel blue (L161 Slate blue)
50	54	E-Color 161: Slate blue (L161 Slate blue)
55	59	E-Color 165: Daylight blue (L165 Daylight blue)
60	64	E-Color 353: Lighter blue (L353 Lighter blue)
65	69	Supergel 68: Parry sky blue (L68 Sky blue)
70	74	Supergel 79: Bright blue (L79 Just blue)
75	79	Supergel 82: Surprise blue (L723 Surprise blue)
80	84	E-Color 119: Dark blue (L119 Dark blue)
85	89	E-Color 363: Special medium blue (L363 Special medium blue)
90	94	E-Color 122: Fern green (L122 Fern green)
95	99	E-Color 124: Dark green (L124 Dark green)
100	104	E-Color 138: Pale green (L138 Pale green)
105	109	E-Color 134: Golden amber (L134 Golden amber)
110	114	E-Color 147: Apricot (L147 Apricot)
115	119	E-Color 101: Yellow (L101 yellow)
120	124	E-Color 105: Orange (L105 orange)
125	129	E-Color 344: Violet (L328 Follies pink)
130	134	E-Color 180: Dark lavender (L706 King fals lavender)
135	139	E-Color 106: Primary red (L182 Light red)
140	199	-
200	204	White : 6500 Kelvin
205	209	White : 6000 Kelvin
210	214	White : 5600 Kelvin
215	219	White : 4200 Kelvin
220	224	White : 4000 Kelvin
225	229	White : 3500 Kelvin
230	234	White : 3200 Kelvin
235	239	White : 3000 Kelvin
240	244	White : 2700 Kelvin
245	249	White : 2200 Kelvin
250	255	CCT channel activated

### 5.2.5.2 CCT (Color Control Temperature)

Range min	Range max	Function
		Function activated if Colour presets channel $\geq 250$
0	255	Colour temperature: 2200 K --> 6500 K

### 5.2.5.3 Strobe duration

Range min	Range max	Function
0	0	Strobe OFF
1	255	Strobe ON - 1ms --> 85ms

### 5.2.5.4 Strobe speed

Range min	Range max	Function
0	255	Frequency: 5,8 Hz --> 11,5 Hz

### 5.2.5.5 Response time

Range min	Range max	Function
0	250	Dimmer timing: 0,1s --> 4 s
251	255	OFF

### 5.2.5.6 Control mode

Range min	Range max	Function
0	0	
1	255	RDM deactivated

### 5.3 RDM remote control

#### 5.3.1 Protocol:

#### ANSI E1.20 – 2010 / ANSI E1.37 - 1

For more information about RDM protocol: <http://www.rdmprotocol.org/>

#### 5.3.2 Functions:

PID	Description	Commentary	ID	UID Description	get	set
Ox0002	DiscoveryMute					
Ox0003	DiscoveryUnmute					
Ox0050	(Get) SupportedParameters				X	
Ox0060	(Get) DeviceInfo				X	
Ox0070	(Get) ProductDetailIDList				X	
Ox0080	(Get) DeviceModelDescription				X	
Ox0081	(Get) ManufacturerLabel				X	
Ox0082	(Get/Set) DeviceLabel				X	X
Ox0090	(Get/Set) FactoryDefaults				X	X
Ox00C0	(Get) SoftwareVersionLabel				X	
Ox00E0	(Get/Set) DMX512Personality				X	
Ox00E1	(Get) DMX512PersonalityDescription				X	
Ox00F0	(Get/Set) DMX512StartingAddress				X	X
Ox0120	(Get) SlotInfo				X	
Ox0121	(Get) SlotDescription				X	
Ox0200	(Get) SensorDefinition				X	
Ox0201	(Get) SensorValue				X	
Ox0343	(Get/Set) Curve	E1.37-1			X	X
Ox0344	(Get) CurveDescription	E1.37-1			X	
Ox0345	(Get/Set) OutputResponseTime	E1.37-1			X	X
Ox0346	(Get) OutputResponseTimeDescription	E1.37-1			X	
Ox0400	(Get) DeviceHours				X	
Ox0401	(Get) LampHours				X	
Ox0500	(Get/Set) Display Invert				X	X
Ox0501	(Get/Set) Display Level				X	X
Ox0601	(Get/Set) Tilt Invert				X	X
Ox0641	(Get/Set) LockState	E1.37-1			X	X
Ox0642	(Get) LockStateDescription	E1.37-1			X	
Ox1000	(Get/set) IdentifyDevice				X	X



## 5.4 Art-Net remote control

### 5.4.1 Protocol: **Artistic Licence Art-Net**

For more information about RDM protocol: <http://art-net.org.uk/>

### 5.4.2 Configuration:

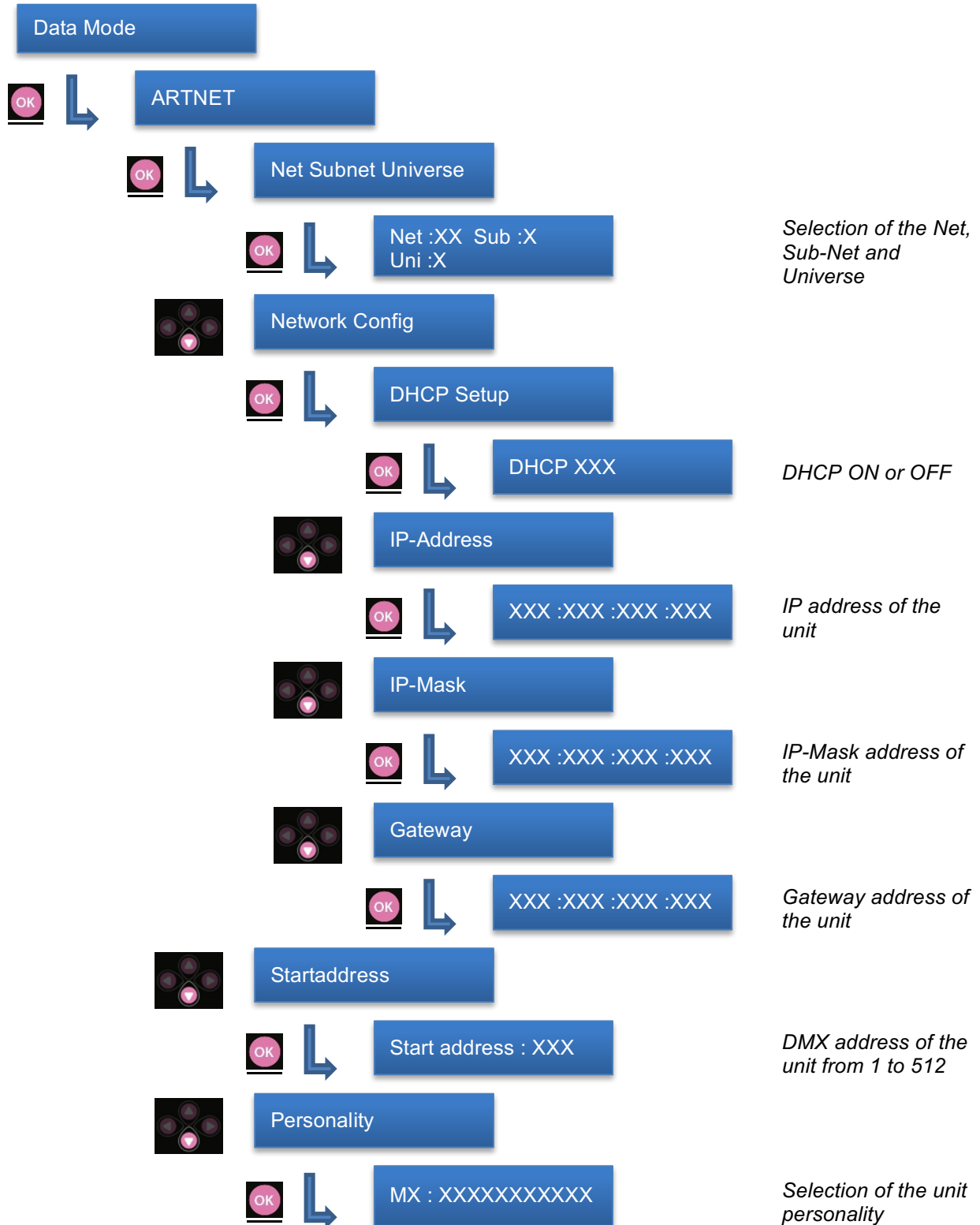

**5.5 sACN remote control**

5.5.1 Protocol: **ANSI E1.31 – 2009 sACN (Streaming-ACN)**

5.5.2 Configuration:

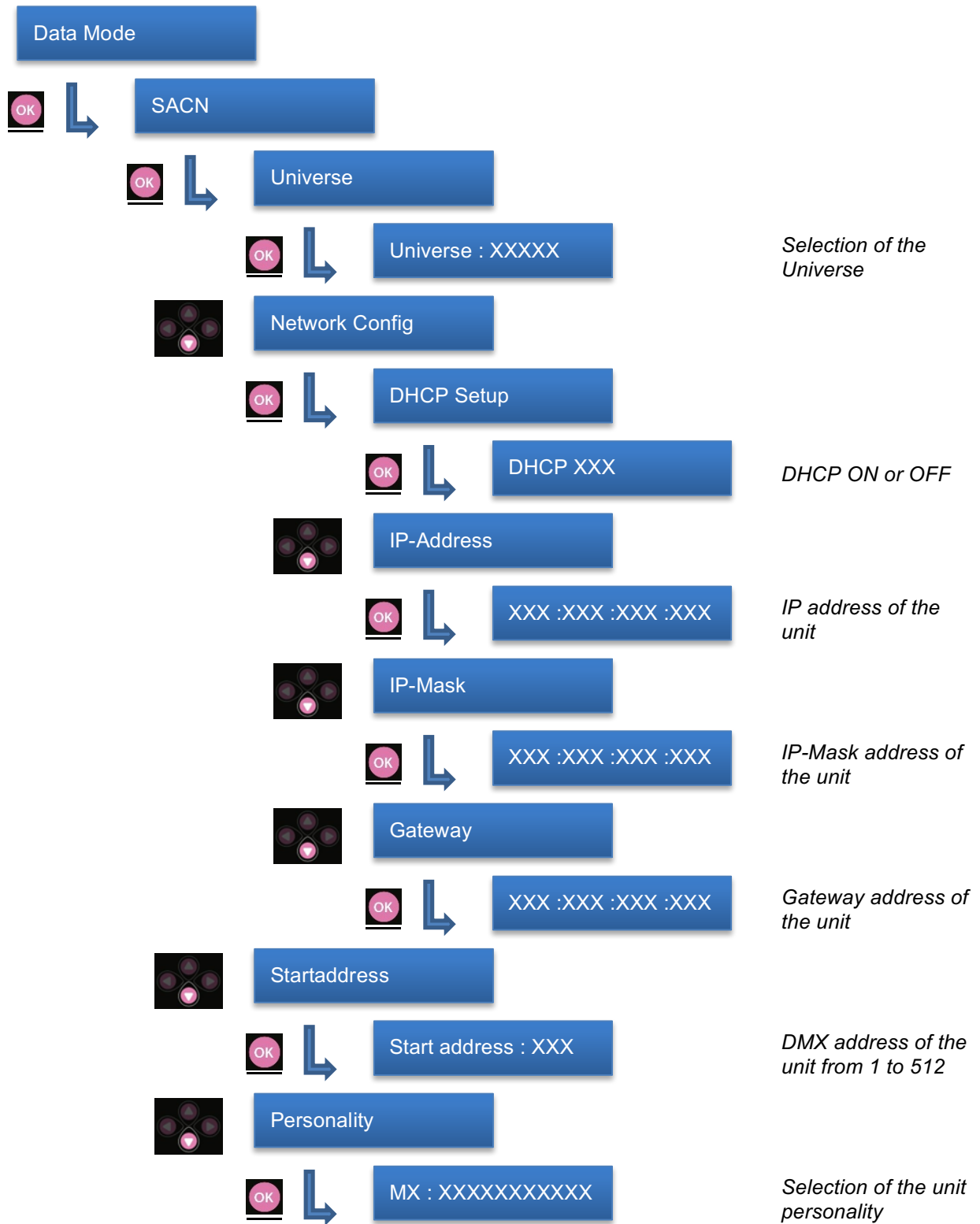

## 6 Service

### 6.1 Preventive maintenance

#### 6.1.1 Frequency

General maintenance should be performed at least once a year or more frequently if the equipment is operated in adverse conditions (smoke, heat, humidity, touring, etc.).

#### 6.1.2 General cleaning

Remove dust from the unit.

Front glasses can be cleaned with solutions containing alcohol.

#### 6.1.3 General visual check

- No trace of heat.
- No loose contacts.
- No missing parts.
- Tighten mechanical assemblies (screws, bolts and nuts, etc.).

### 6.2 Analysis

In case of problem, contact RJ distributor with the following information:

- Model, version and serial number of the product.
- From the menu status:
  - Software version
  - LED board IDs
  - Device hours
- Description of the problem.

### 6.3 Electronic thermal management system

In case of overheating, light intensity will be reduced by the system. "Power reduction X%" will be shown on the display with the reducing percentage.

### 6.4 Firmware update

1. Firmware available on [www.robertjuliat.com](http://www.robertjuliat.com)
2. Download and unzip the file
3. Switch on Dalis and config IP address (*DATAMODE>ARTNET>IP-CONF*):
  - a. *DHCP = OFF*
  - b. *ADDRESS = AAA.BBB.CCC.XXX*
  - c. *MASK = 255.0.0.0*
  - d. Exit to main menu to validate modifications
4. Set the Network IP of the computer :
  - a. *ADDRESS = AAA.BBB.CCC.YYY* with *YYY ≠ XXX*
  - b. *MASK = 255.0.0.0*
5. Connect Network from computer to Dalis, if you don't have an Auto MDI-X or a switch, use a cross link cable
6. Open a web browser (Internet Explorer, Firefox, Chrome...)
7. Enter the URL address of the Dalis: *http://AAA.BBB.CCC.XXX*
8. First, install the Main Program
  - a. *Select the firmware file dalis860\_VX.XX.upd*
  - b. *Press submit button*
9. Install the Bootloader
  - a. *Select the firmware file dalis\_bootloaderVX.XX\_boot.upd*
  - b. *Press submit button*
10. Update message displays on Dalis display
11. When the update is completed, the Dalis shows the new firmware version

### 6.5 Factory defaults

Select FACTORY DEFAULT in the main menu to reset all values and parameters

# APPENDIX 1



## OPERATING & ASSEMBLY INSTRUCTION NAC3FX-W | powerCON TRUE1

### A. OPERATING INSTRUCTION

#### Application:

The powerCON TRUE1 system is certified as connector with breaking capacity according IEC 60320, VDE 0625. It is intended for use as appliance couplers and interconnection couplers. It serves to supply power to an appliance and from an appliance to another equipment. To be installed by qualified person only.

#### Connector Assignment:

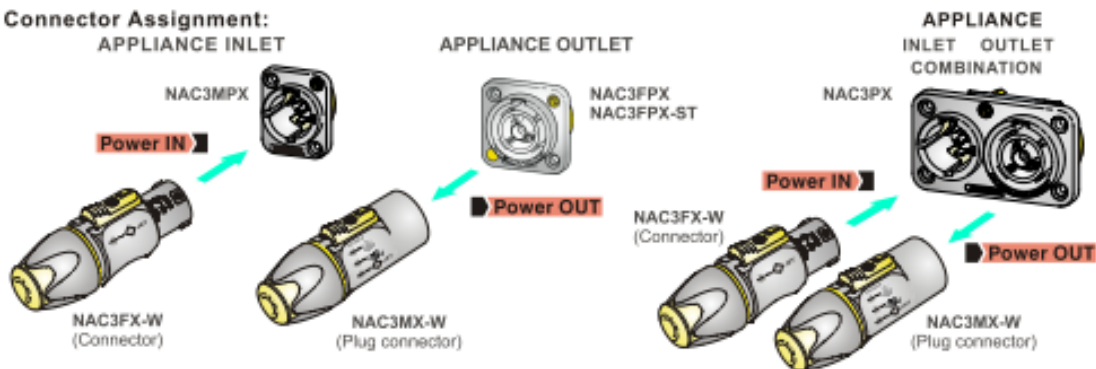

<b>Approval based:</b>	<b>VDE</b> EN 60320-1/EN60320-2-2	<input checked="" type="checkbox"/>	<b>UL</b> UL 498 / CSA C22.2 No. 182.3	<input checked="" type="checkbox"/>
<b>Rating:</b>	250 V ac / 16 A		250 V ac / 20 A	
<b>Cable Type:</b>	H05VV-F3G 1.0 mm <sup>2</sup> , Length max. 2 m H05VV-F3G 1.5 - 2.5 mm <sup>2</sup> H07RN-F3G 1.5 mm <sup>2</sup>		SJTOW, SJOOW 3 x 12 AWG	
<b>Strain Relief:</b>	White chuck		White chuck	
<b>Cable O.D.:</b>	6.0 - 12.0 mm		6.0 - 12.0 mm	

### B. ASSEMBLY INSTRUCTION

- A** Insert cable into the bushing and housing.  
Note: "Apply cable pulling lubricant to cable jacket."

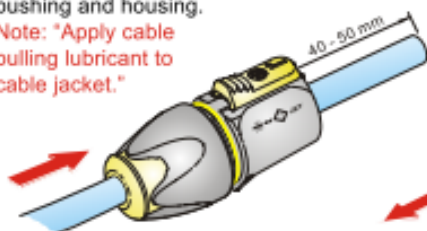

- B** Separate the housing from the bushing (cable remain in bushing)

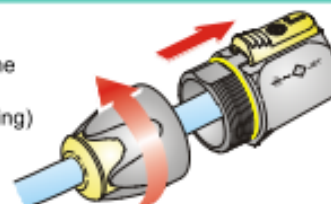

- C** Place chuck over the cable.

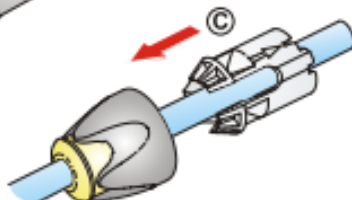

- D** Prepare cable as shown.

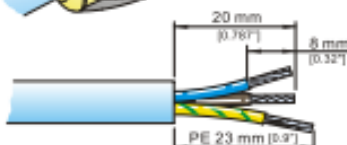

VDE (EN 60320-1/EN60320-2-2)

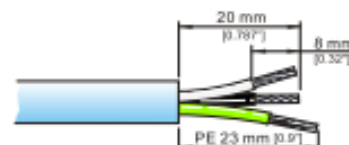

UL (UL 498 / CSA C22.2 No. 182.3)

# APPENDIX 1

**E**

Torx size T8  
Torque Value 0.7 Nm

Slide the cable into the contacts and clamp with the screw with Torx size T8.

Wiring	VDE	UL
L ⇒	■ brown	■ black
N ⇒	■ blue	□ white
⊥ ⇒	■ green/yellow	■ green

**F**

Important: Push and turn simultaneously.

Slide chuck onto insert (1) and then both into housing (2).  
Important: Align the chuck by positioning the nose into keyway.

Torque Value 2.0Nm

**G**

PRESS FIRMLY

Wrench size 13 mm

Slide the cable clamp (3) bushing up the cable and tighten it with the tool (4) as shown (5).  
Important: Yellow O-ring to hide to achieve IP protection (6).

(Tool available: Art. No. HTAC)

**Disassembly (open twist lock):**

1. Press with screw driver to unlock
2. Turn bushing while still pressing locking.

**CAUTION**

To ensure protection category, do not expose the connection to bending forces (e.g. do not attach loads to the cable, no free-dangling cable windings etc.).

**FORCE**

NEUTRIK AG	LI	T: +423/237 24 24	F: +423/232 55 95	NEUTRIK France	FR	T: +33 1/4131 6750	F: +33 1/4131 6611
NEUTRIK USA Inc.	USA	T: +1 704/972 3050	F: +1 704/438 9002	NEUTRIK Tokyo Ltd.	JP	T: +81 3/3963 4733	F: +81 3/3963 4796
NEUTRIK (UK) Ltd.	UK	T: +44 1963/811 441	F: +44 1963/811 439	NEUTRIK Hong Kong Ltd.	HK	T: +852/2687 6055	F: +852/2687 6052
NEUTRIK Vertriebs GmbH	DE/NL/AT/DK	T: +49 8131/280 890	F: +49 8131/280 830	NEUTRIK India Pvt. Ltd.	IND	T: +91/982 06 43 424	F: +91/22 26163 540

Draft Nr.: BDA 378 | Update: 08.04.2014 | Data subject to change without prior notice. ©2014 NEUTRIK®. ALL RIGHTS RESERVED. NEUTRIK® are registered trademarks.