

DIGIRUSS

DW45R

WIRELESS MICROPHONE

USER MANUAL

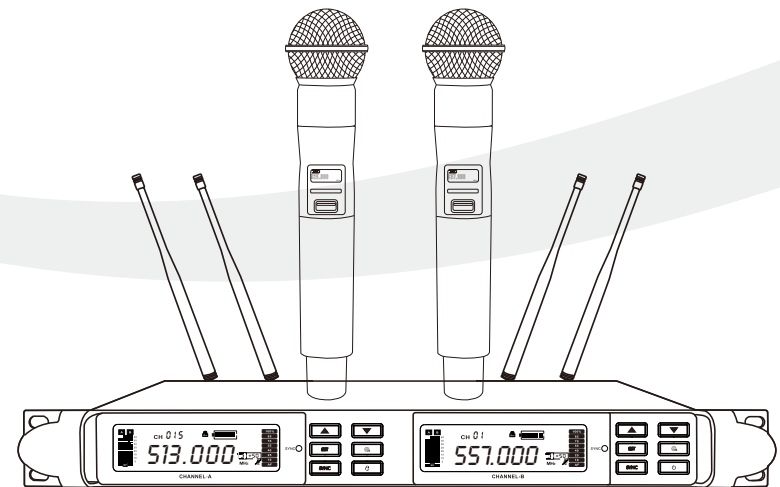





UHF Wireless Microphone

Statment The pictures in the manual are for reference only. Please refer to the real product (including but not limited to color, size, screen display, etc.). The company has the right to change the product or specification at any time without prior notice.

User Manual

Thank you for purchasing our product, in order to make our products a better performance, please read the instructions carefully before using.

⚠ CAUTIONS ⚠

1. Turn off the Power before installing ,removing and wiring the equipment .
Otherwise ,there will be a risk of electric shock.
2. Do not disassemble the machine, otherwise it will cause failure
3. Please use the unit within the following conditions(temperature,humidity ,
vibration ,installation direction, environment ,etc .)Otherwise,there is a
risk of fire or malfunction.
4. Do not block the ventilation holes of the equipment. Otherwise,there is a
risk of fire or malfunction.
5. Please follow the standard of the machine connection, the specified
power supply and construction method, and wire it correctly.Otherwise,
there is a risk of electric shock, fire, or malfunction.
6. Do not let the broken wire, iron power, water inside the case.Otherwise ,
there will be a risk of fire.
7. When disposing of the machine, please follow the local regulations,
Properly handled according to industrial waste. 
8. The equipment must be exposed to water droplets or water splashes. 
9. The equipment should be connected to the grid power outlet with
protective grounding.
10. If the power plug and appliance coupler are used as disconnect
devices, the disconnect device should kept easy to operate(Such as
knife switch or leakage switch)
11. The equipment is only suitable  for safe use in areas below with an
elevation of 2000 meters. 
12. The equipment is only suitable for safe use in non-climte conditions. 



XII. Troubleshooting

Fault	Indicator Status	Methods Of Resolution
No sound or weak sound	The battery indicator is off, when the transmitter is turn off/on.	Confirm that the "+ / -" mark on the battery is terminated with the transmitter are matched and install a new battery.
	Receiver indicator is off	Check whether one end of the AC adapter is plugged into the DC input jack on the back panel of the receiver. Check and confirm whether the AC power socket is normal and confirm whether the power supply voltage is correct.
	Signal indicator is on,the audio indicator flashes with the sound	The audio peak indicator flashes at high volume input. Turn up the volume control on the receiver.
	The transmitter display flashes	Low battery voltage, replacement of transmitter battery
The degree of distortion gradually increased	The receiver signal indicator and the transmitter low battery indicator are on	Replacement of transmitter battery
There are bursts of noise or radio, broadcast sound	The receiver signal indicator lights up	Find the interference source (other RF signal source), turn it off or move it away, or use a different frequency line system.
The transmitter user occasionally loses his voice during the move -ment of the per -formance site	When the sound is lost, the signal light is not on	Change the position of the receiver and repeat the "rehearsal test" on the audio system. If there is still a sound loss point, mark the dead point and avoid going here during the performance.

XI. Technical Parameter

Receiver Technical Parameter

Frequency Range	513.000-557.750MHz
Modulation Mode	FM
Oscillation Mode	PLL Phase Locked Frequency Synthesizer
Frequency Stability	±0.0005%
Sensitivity	-44dB
Maximum Offset	±45kHz
Bandwidth	40MHz
S/N Ratio	108dB
T.H.D	0.4%@1KHz
Frequency Response	65Hz~18kHz,±3dB
Maximum Output Voltage	Balanced:-20dB/100Ω
Unbalanced	-4dBV/5KΩ
Output Socket	XLR Balance;φ6.3 Unbalance
Panel Keys	Handheld&Lapel button switch display
Working Distance	About 100M(Under ideal environment)
Power Supply	DC12V-2A

Transmitter Technical Parameter

Carrier Frequency Band	513.000-558.000MHz
Oscillation Mode	PLL Phase Locked Frequency Synthesizer
Harmonic Radiation	-63dBm
Bandwidth	80MHz
Maximum Offset	±45kHz
Power Consumption	3mW
Frequency Response	50Hz~18kHz
Maximum Input Sound Pressure	130dB SPL
Pickup Head	Handheld:Moving Coil ;Headset/Lapel:Condenser
Polar directivity	Cardioid

Contents

I. Product Instruction	(01)
II. Product Feature	(02)
III. Standard Configuration List	(02)
IV. Panel Instruction	(03)
V. Display Screen	(04)
VI. System Operation Instruction	(05-06)
VII. Handheld Mic Instruction	(07)
VIII. Lapel Mic Instruction	(08)
IX. IR Frequency Matching	(09)
X. Product Connection.....	(10)
XI. Technical Parameter	(11)
XII. Troubleshooting.....	(12)

I. Product Instruction

Adopts leading high-tech designs : UHF transmission, real diversity reception, dual CPU control, liquid crystal display, metal shell, PLL technology, noise detection, etc. It has 180 frequency points adjustable and easy to use.

Microcomputer CPU control: The whole hardware circuit of the system is controlled by microcomputer, which can carry out frequency selection, display, mute locking, battery capacity monitoring and other processing.

Liquid crystal display: High performance liquid crystal is used for display, and all control menus can be displayed on the liquid crystal screen to facilitate the control of the system.

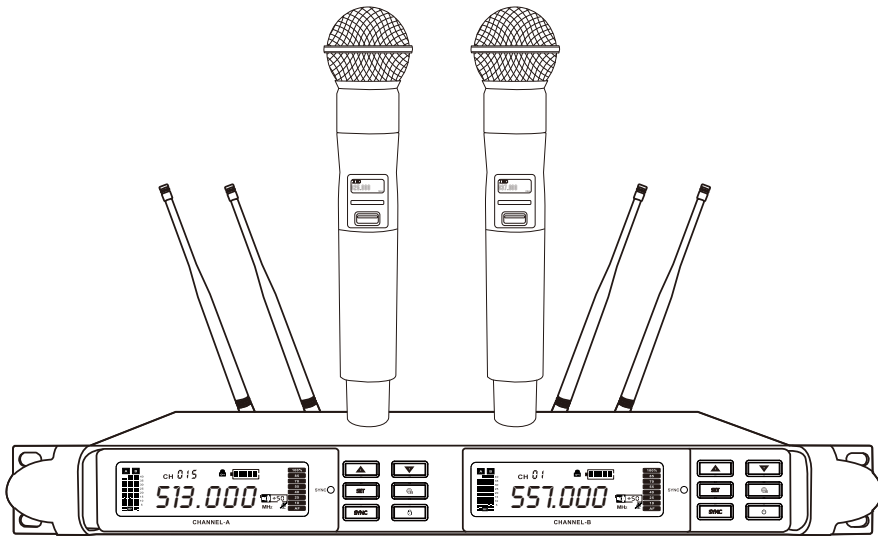

X. Product Connection

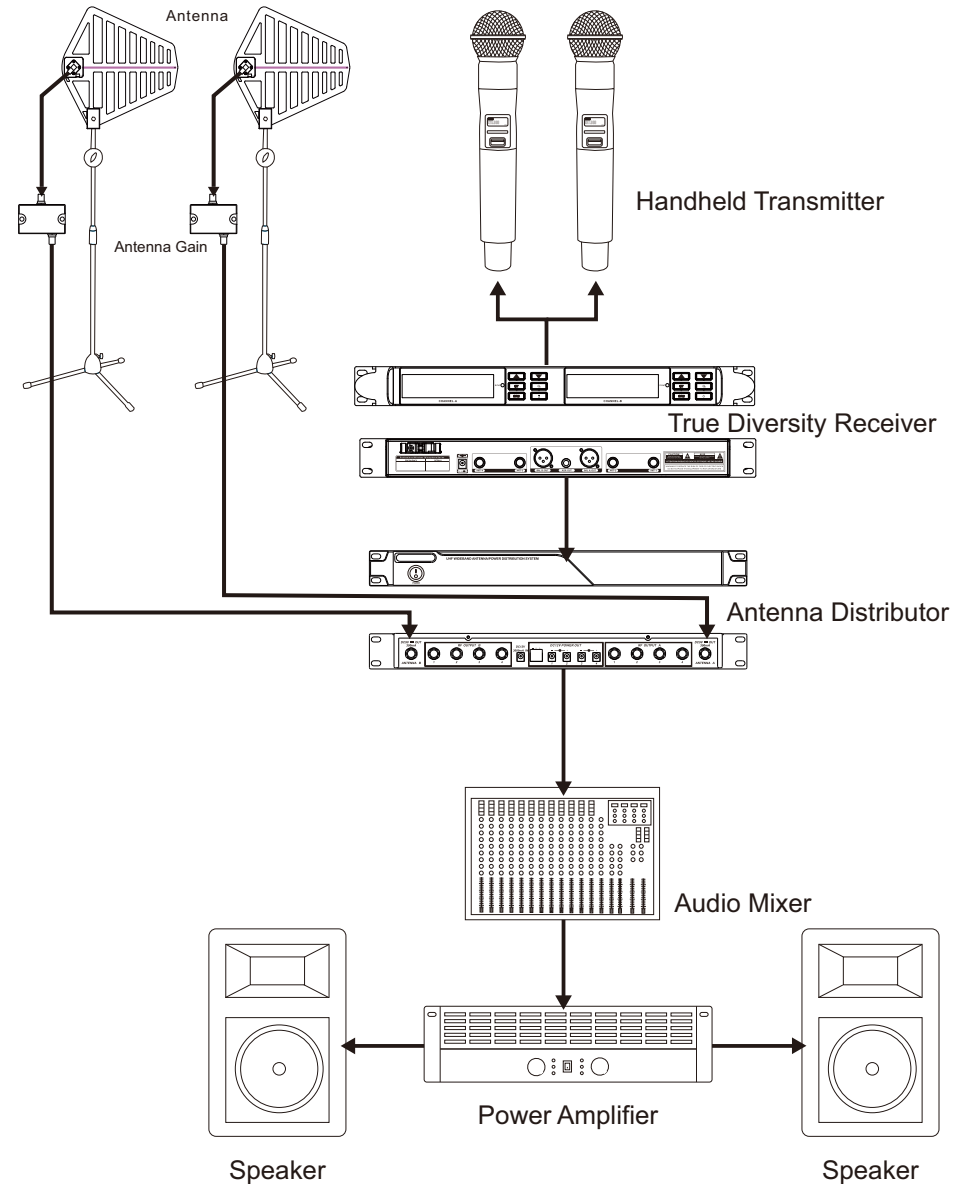

IX.IR Frequency Matching

An infrared transmission system.

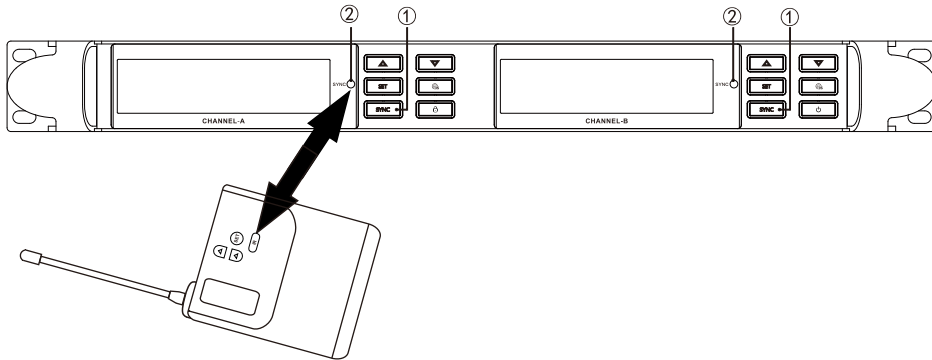
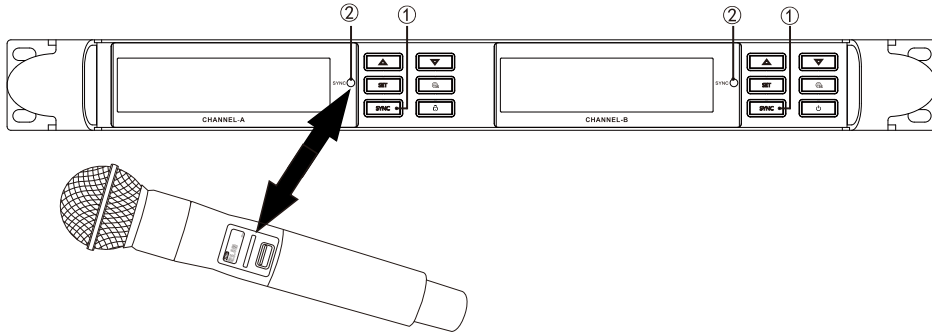

1. Turn on the transmitter and receiver power;
 2. Press "SYNC" ① key on the receiver, the receiver LED display IR flashing;
 3. Face the transmitter IR window to receiver IR window, frequency matching.
- The transmitter frequency and the receiver frequency will become the same after frequency matching succeed. (If frequency matching failure, repeat the same operation as above)

II. Product Feature

1. Adopted UHF to avoid interference frequency;
2. Low transmission delay and long transmission distance;
3. Fully integrated chip scheme, stable product performance;
4. 2 x 80 adjusted channels;
5. Enhanced wireless reception;
6. Large LCD display;
7. With automatic search for clean channels;
8. The hand microphone with intelligent mute function;
9. Electronic volume adjustment function;
10. With balanced output and mixed output.

III. Standard Configuration List

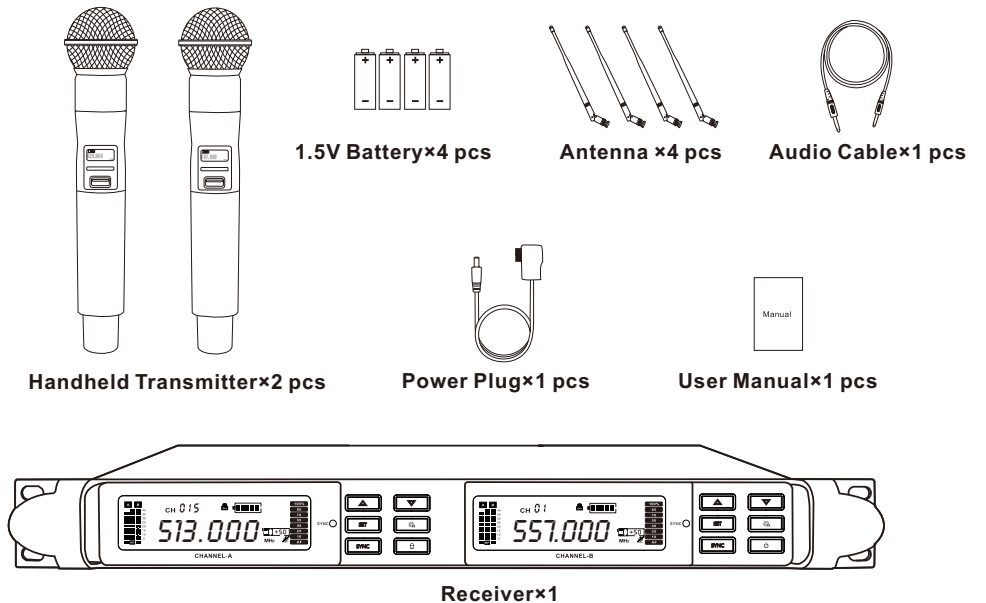

IV. Panel Instruction

Front Panel Instruction

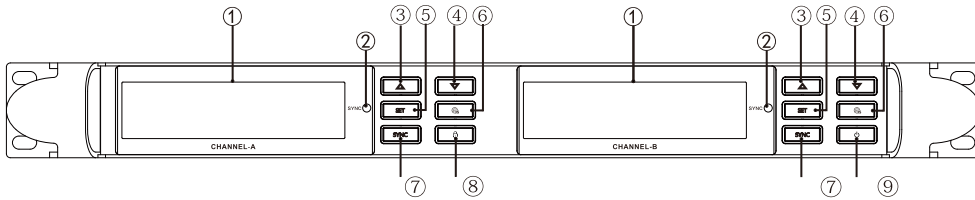

- ① 3.5inch TFT screen;
- ② IR window;
- ③ Volume increase/Up selection Key;
- ④ Volume reduction/Down selection Key;
- ⑤ Press“SET” key ,through UP and Down key set receiver channel ,frequency, press “SET”key to save after setting finish;
- ⑥ Scan frequency key to search the frequency automatically;
- ⑦ Press the “SYNC” key to match the receiver and transmitter frequency;
- ⑧ “Lock”key,lock the receiver screen;
- ⑨ Power switch.

Rear Panel Instruction

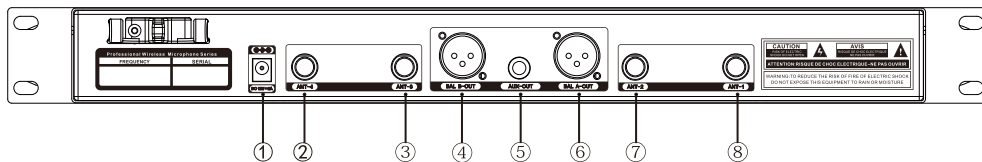

- ① Power Socket(DC IN);
- ② CH4 Antenna Interface;
- ③ CH3 Antenna Interface;
- ④ Audio output,3-pin interface, balance output(AF OUT BAL)(B)
- ⑤ Audio output,6.35mm interface, unbalance output(AF OUT UNBAL)
- ⑥ Audio output,3-pin interface, balance output(AF OUT BAL)(A)
- ⑦ CH2 Antenna Interface;
- ⑧ CH1 Antenna Interface;

VIII.Lapel Mic Instruction

Bodypack Instruction

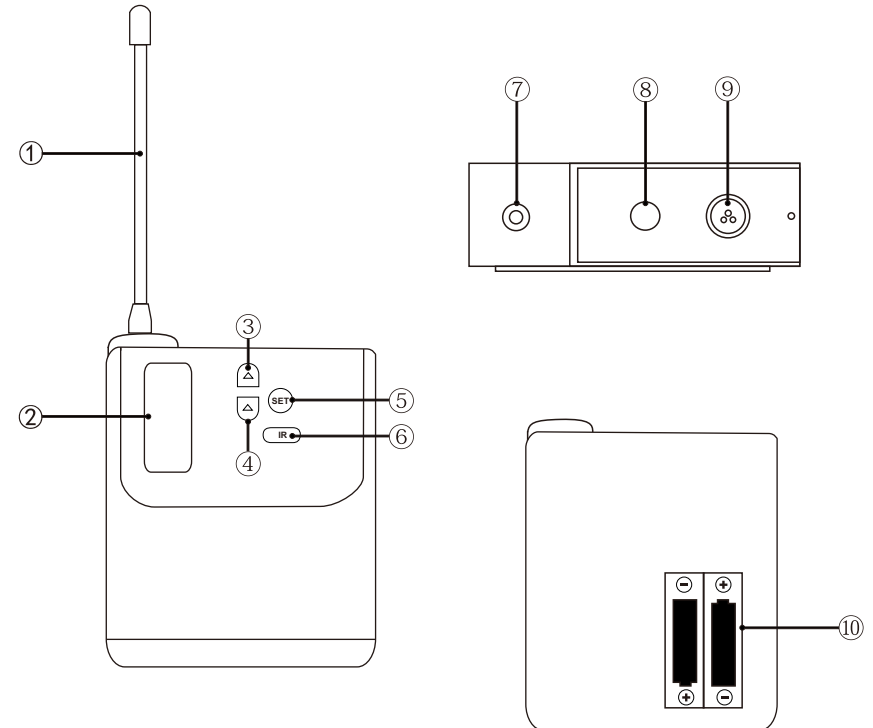

- ① Bodypack antenna;
- ② Led display;
- ③ Up selection key;
- ④ Down selection key;
- ⑤ “SET” function key;
- ⑥ IR window;
- ⑦ Antenna Interface;
- ⑧ Power Switch;
- ⑨ Microphone interface;
- ⑩ Power slot.

VII. Handheld Mic Instruction

Handheld transmitter Instruction

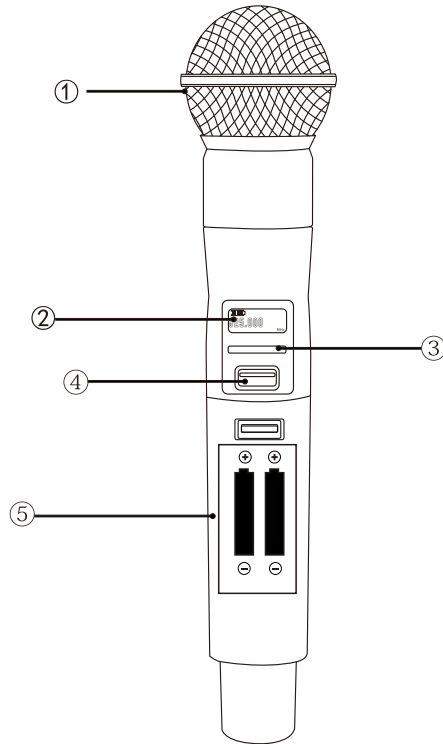

- ① Pickup net;
- ② LCD display;
- ③ IR window;
- ④ Power switch;
- ⑤ Battery slot.

V. Display Screen

Receiver display screen

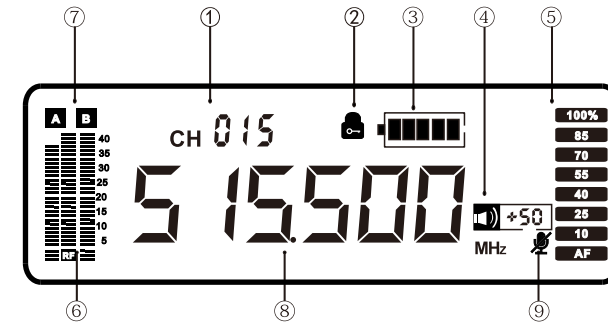

① Channel	Channel number
② Lock key	After enabling, the panel is locked
③ Microphone battery level	100%
	75%
	50%
	25%
	Battery is running out,replace it asap
④ Microphone volume level	Display microphone volume level
⑤ Audio volume level	Display input audio volume level
⑥ Antenna signal level	Display antenna signal level
⑦ Antenna signal receiving status	When display "A", means antenna A signal input
	When display "B", means antenna B signal input
⑧ Frequency	Display frequency currently used
⑨ Microphone status	Display microphone connection status

VI. System Operation Instruction

Panel function key introduction

- “△” Volume increase/Up selection key, press directly to increase volume;
- “▽” Volume reduction/Down selection key, press directly to reduction volume;
- “SET” Press “SET” then through UP and Down key set receiver channel , frequency, press “SET”key to save after setting finish;
- “🔍” Scan frequency key to search the frequency automatically;
- “SYNC” Press the “SYNC” key to match the receiver and transmitter frequency;
- “🔒”,lock the receiver screen;

Search frequency automatically

Press “🔍”,the receiver screen display as below:

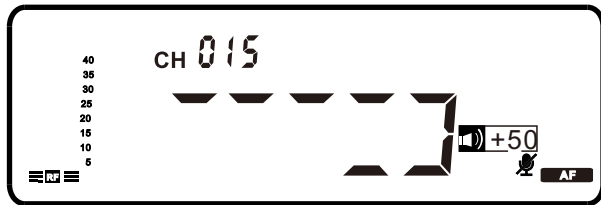

Press “🔍” key, the system will automatically sweep the frequency, the receiver screen will scrolling the digital. After display “IR”,roofreading the handheld mic frequency, when the screen digital become white color, the operation succeed.

Lock key

Press “🔒”,the receiver screen display as below:

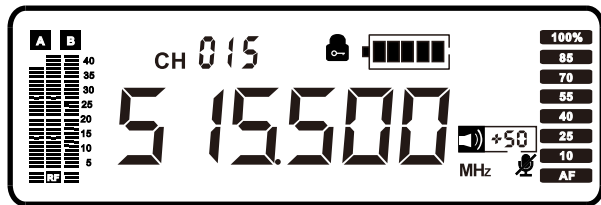

Long press “🔒”3 seconds ,enter “🔒” status,the panel will be locked.

Long press “🔒”3 seconds to unlock.

Set channel manually

The receiver will display as below:



Press “SET”,then press “△” or “▽” to select “CHAN”as above, press “SET” to enter the channel setting, through “△” and “▽” key set receiver channel ,press “SET”key to save.

Set receiver signal intensity manually

The receiver will display as below:



Press “SET”,then press “△” or “▽” to select “SQ”as above, press “SET” to enter the signal intensity setting, there are 3 signals can be select “-95/-90/85”,through “△” and “▽” key to select ,press “SET”key to save.

- Noted:1.The smaller the sensitivity, the shorter the wireless receiving distance and the stronger the anti-interference.
2.The greater the sensitivity, the longer the wireless receiving distance and it is easy to receive other signals.

Set receiver signal intensity manually

The receiver will display as below:



Press “SET”,then press “△” or “▽” to select “FREQ”as above, press “SET” to enter the Frequency setting, through “△” and “▽” key set receiver channel ,press “SET”key to save.