

CHARLES - 963SX

960SX - LED 600 W



- **Type:** Profile spot
- **Source:** LED 600 W
- **Optics:** 29° to 50° zoom
- **Colour temperature:** Cool White

Profile spot

The bright new classic in LED profile technology with mighty output

Sharing its technology, output and quality of light with Oz and Alice, Robert Juliat presents its brilliant range of LED profiles, the Charles 960SX series. This range of 600W LED profiles is available in 3 variable zoom ranges and exhibits a high optical efficiency with a 6000K colour temperature and a CRI in excess of 90. Smooth electronic dimming and an in-built, flicker-free power supply gives silent operation and packs a high output that reaches 80% of the renowned 2.5 kW HID D'Artagnan capabilities.

Features

- **Multi-function double gate:** simultaneous use of gobos and iris. Sharp focus of both gobo and shutter
- **Shutter gate:** up to 8 shutters. Remove shutters for easy maintenance or tuck fully inside gate for secure transport
- **User-friendly shutter-lock system:** secures shutters' setting in any circumstances (locking efficient up to 4 shutters)
- **Universal gobo holder:** "A" size glass and metal gobo
- **Lens tube lock feature:** secures rotating lens tube against unwanted movement
- **90° rotating lens tube / gate / front accessories holder:** rotation of the projected image is always possible – no need to move the yoke
- **Internal glass filter holder:** long term use of durable coloured, dichroic or textured glass
- **XLR7 connector:** for fan cooled front extension cassette (recommended for dark colours)
- **Adjustable response time:** choice of fast or slow dimming for tungsten-like simulation - adjustment by DMX protocol
- **Ethernet-DMX node:** data IN through RJ45 connector; data OUT through DMX for daisy chaining
- **Universal data control:** compatible with DMX, RDM, Art-Net, sACN protocols
- **Remote setup:** all parameters can be adjusted by RDM protocol
- **DMX:** 8 or 16 bit dimming and strobe function
- **Local setup:** dMX address and mode, dimming curve and response time through 4-button display with automatic light switch-off
- **Control:** local and DMX
- **Dimming parameters:** choice of square or linear dimming curves
- **Easy focus reference:** graduated scale on side of the unit; fast and easy refocusing
- **Tilt reference on hanging yoke:** index for rapid re-positioning

Optical

- **Long life:** outstanding operational lifetime expectation, no need to replace lamps, low maintenance
- **Gobo :** excellent gobo projection
- **Variable zoom optics:** sharp focus at every beam angle. Independent control of image size and focus. Focus handles on both sides
- **Electronic dimmer:** dimming without clipping or cut-out at low intensity levels; high quality smoothing
- **No colour shift:** colour temperature remains the same when dimming

Construction

- **Made in France :** fully manufactured in Robert Juliat premises retaining complete control over all aspects of quality
- **PSU:** built-in electronic flicker-free power supply for easy, plug-and-play installation
- **Power connectors:** neutriK® powerCON TRUE1 TOP IN and OUT connectors for daisy chaining
- **Silent-running cooling fans:** ideal for TV studios and opera houses
- **Electronic thermal management system:** ensures maximum performance of the system without any risk of overheating
- **Bodywork:** strong sheet metal construction for durability
- **Moving parts:** smooth at all times, even when hot
- **Captive knobs and handles:** additional security when working at height or in transit
- **Spare parts and accessories:** interchangeable across the tungsten, discharge or LED ranges, reducing running costs
- **Easy access to all parts:** easy cleaning and maintenance

Picture:963SX

DSEN354_963SX - 23/03/2022

Robert Juliat reserves the right to change or alter any of the items detailed on this page, to increase or improve manufacturing techniques without prior notice.

Robert Juliat S.A.S., 32 rue de Beaumont, 60530 Fresnoy-en-Thelle - France
Telephone : +33 (0)3 44 26 51 89 - fax : +33 (0)3 44 26 90 79 - info@robertjuliat.fr
www.robertjuliat.com



ROBERT JULIAT

- Lamp type: LED
- Power: 600 W

| LED specifications | Power * | Lumen output* | Colour temperature* | Life* | CRI* (min) |
|--------------------|---------|---------------|---------------------|----------|------------|
| LED 600W | 600 W | 32 500 lm | 6000K | 20 000 h | 91 |

Life data following L70B50 standard - (*) manufacturer's data

Optics

Characteristics

- Type: Zoom
- Beam range: 29° to 50°
- Focal length: 82 - 144 mm

Gel filter

- Shape: Square
- Standard size: 215x215 mm (8.5x8.5 in)
- Optional size: 245x245 mm (9.6x9.6 in)

Gobo

- Size: A
- Material: Metal
Glass

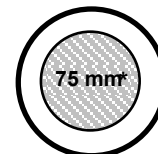

100 mm
*Maximum image size

Photometrics

with LED 600W source

• Optics @ 29°

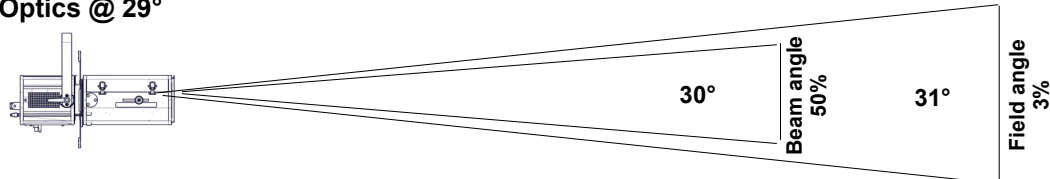

Beam intensity
97 000 cd

Field lumens
18 680 lm

Efficacy
29 lm/W

| | | | | | | |
|--------------|-----------|---------|---------|---------|---------|---------|
| Distance | 5 m | 10 m | 15 m | 20 m | 25 m | 30 m |
| Diameter | 2.8 m | 5.5 m | 8.3 m | 11.1 m | 13.9 m | 16.6 m |
| Illumination | 3 900 lux | 980 lux | 440 lux | 250 lux | 160 lux | 110 lux |
| Distance | 15 ft | 35 ft | 50 ft | 65 ft | 80 ft | 100 ft |
| Diameter | 8.3 ft | 19.4 ft | 27.7 ft | 36.1 ft | 44.4 ft | 55.5 ft |
| Illumination | 440 fc | 80 fc | 39 fc | 23 fc | 16 fc | 10 fc |

• Optics @ 50°

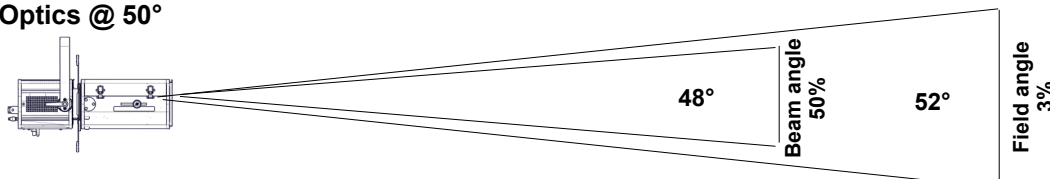

Beam intensity
39 900 cd

Field lumens
21 050 lm

Efficacy
33 lm/W

| | | | | | | |
|--------------|-----------|---------|---------|---------|--------|---------|
| Distance | 5 m | 10 m | 15 m | 20 m | 25 m | 30 m |
| Diameter | 4.9 m | 9.8 m | 14.6 m | 19.5 m | 24.4 m | 29.3 m |
| Illumination | 1 600 lux | 400 lux | 180 lux | 100 lux | 65 lux | 45 lux |
| Distance | 15 ft | 35 ft | 50 ft | 65 ft | 80 ft | 100 ft |
| Diameter | 14.6 ft | 34.1 ft | 48.8 ft | 63.4 ft | 78 ft | 97.5 ft |
| Illumination | 180 fc | 33 fc | 16 fc | 10 fc | 7 fc | 4 fc |

Remote control

- Data protocol: USITT DMX512-A
RDM / Art-Net / sACN

- Data IN connector: 5 pins XLR mâle + etherCON RJ45
- Data OUT connector: 5 pins XLR femelle



• DMX chart:

Mode 1 (1 channels)

Dimmer

Mode 2 (2 channels)

Dimmer
Dimmer fine

Mode 3 (5 channels)

Dimmer
Strobe duration
Strobe speed
Response time
Control mode

Mode 4 (6 channels)

Dimmer
Master dimmer
Strobe duration
Strobe speed
Response time
Control mode

Dimensions and weight

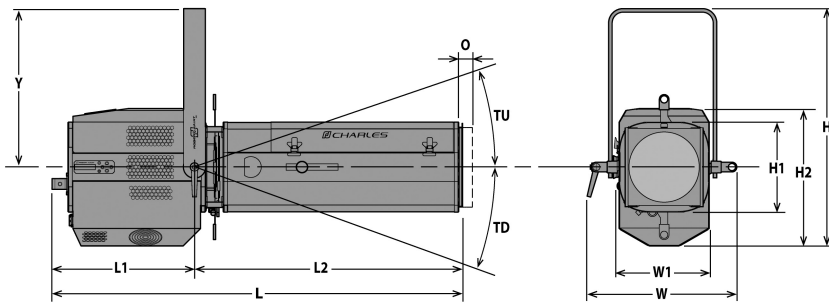

Weight: 30.5 kg (67.1 lbs)

| Height | Length | Width | Yoke | Tilt | Option |
|---------------------|----------------------|---------------------|---------------------|---------|-----------------|
| H= 659 mm (25.9 in) | L= 780 mm (30.7 in) | W= 368 mm (14.5 in) | Y= 440 mm (17.3 in) | TU= 68° | O= 25 mm (1 in) |
| H1= 250 mm (9.8 in) | L1= 395 mm (15.6 in) | W1= 250 mm (9.8 in) | | TD= 90° | |
| H2= 381 mm (15 in) | L2= 385 mm (15.2 in) | | | | |

Shipping

- **Weight :** 41 kg (90.2 lbs)
- **Volume :** .3 m³ (10.59 ft³)

Installation

- **Minimum distance to illuminated surface:** 0.2 m (0.7 ft)
- **Operating position:**

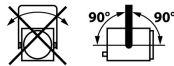

Construction

- **Housing:** Steel sheet - Aluminium
- **Colour:** Black
- **Cooling:** Variable fans
- **Maximum ambient temperature (Ta):** 40°C (104°F)
- **Maximum case temperature (Tc):** 65°C (149°F)
- **Total heat dissipation:** 2 184 BTU/h
- **Ingress Protection (IP) rating:** IP20

Electrical compatibility

- 220/230 V - 50 Hz
- 245 V - 50 Hz
- 110/120 V - 60 Hz
- 208 V - 60 Hz
- 220/230 V - 60 Hz
- 100 V - 50 Hz
- 100 V - 60 Hz
- Selector: automatic detection

Power input



- **Type:** removable power cord with Neutrik powerCON TRUE1 TOP connector (included)
- **Cable:** H07RNF 3G1.5
- **Length:** 3 m (9.8 ft)
- **Power connector:** CEE 7/7 (2P+E NF/Schuko)

Power consumption

| Voltage | Frequency | Current | Power | Power factor |
|---------|-----------|---------|-------|--------------|
| 230 V | 50 Hz | 2.8 A | 640 W | 0.99 |
| 120 V | 60 Hz | 5.5 A | 649 W | 0.99 |
| 100 V | 60 Hz | 6.7 A | 655 W | 0.99 |

Power Supply Unit

- **PSU:** Internal - Electronic PSU - Flicker free with PFC
- **Control:** Local / DMX
- **Protection:** -
- **Power thru:** Neutrik powerCON TRUE1 TOP - Maximum of 5 units (230 V) / 2 units (120 V)

Warranty

- **Fixture: 3 years**
See General Sales Condition on website

Approvals





Acoustics

- **Noise level:** < 38,2 dB(A)













Model

| | |
|--------------|--|
| 963SX | LED 600 W Profile spot - 963SX Charles - Cool White - 29/50° |
|--------------|--|

Options

| | | |
|-----------------|--|---|
| CAV700 | Double slot front cassette for 215x215mm accessories |  |
| CAV700J | Double slot front cassette for 245x245mm accessories |  |
| PCP1716A | 16A blue 2P+E 6h IEC60309 power connector |  |

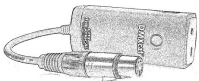
Accessories

| | | |
|-----------------|--|---|
| D8 | Shutter for SX series 4 included |  |
| PF1000M2 | 215x215mm metal filter holder 1 included |  |
| SGUX | Universal "A" size gobo-holder (metal, glass, frosted glass) 1 included |  |
| IWSX755 | Drop-in iris (monoplane) with holder - Poids: 0.26 Kg |  |
| G1000 | 215x215mm safety grid |  |
| CAV700A | Double slot front cassette for 215x215mm accessories - Poids: 0.52 Kg |  |
| CAV700AJ | Double slot front cassette for 245x245mm accessories - Poids: 0.95 Kg |  |
| RPF960 | Front extension cassette for 215x215mm accessories with XLR7 fan (recommended for dark colours on 960SX) - Poids: 1.7 Kg |  |
| RPF960E | Front extension cassette for 245x245mm accessories with XLR7 fan (recommended for dark colours on 960SX) - Poids: 1.7 Kg |  |
| VD120 | 120x120mm frosted glass |  |
| FCD700 | Angled yoke - Poids: 1.62 Kg |  |
| DMXcat | Bluetooth DMX/RDM Multifunction test tool - City Theatrical DMXcat® |  |
| 876 | Hook clamp 40x10mm with 28mm M10 screw for Ø35 to 50mm pipes - SWL: 50Kg - Poids: 1.25 Kg |  |

880

Hook clamp 40x10mm with 28mm M10 screw for Ø50 to 63mm
pipes - SWL: 50Kg - Poids: 1.36 Kg



CS2

Safety cable Ø3 mm L= 600mm - SWL: 75 Kg



Light quality report

| CCT | DeltaUV | CRI Ra | CRI R9 | CQS Qa | TM30-18 Rf | TM30-18 Rg | TLCI |
|--------|---------|--------|--------|--------|------------|------------|------|
| 5 650K | 0.0040 | 90 | 49 | 88 | 88 | 95 | 89 |

CRI - CIE Colour Rendering Index

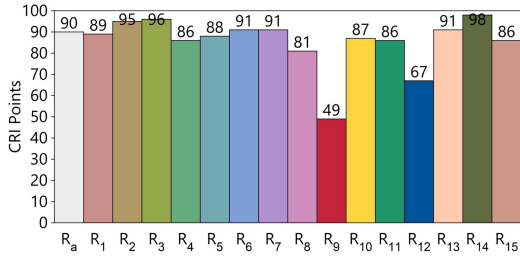

TLCI - Television Lighting Consistency Index

Test : CCT = D5652 (+0.1)
 TLCI-2012 : 89 (D5652)

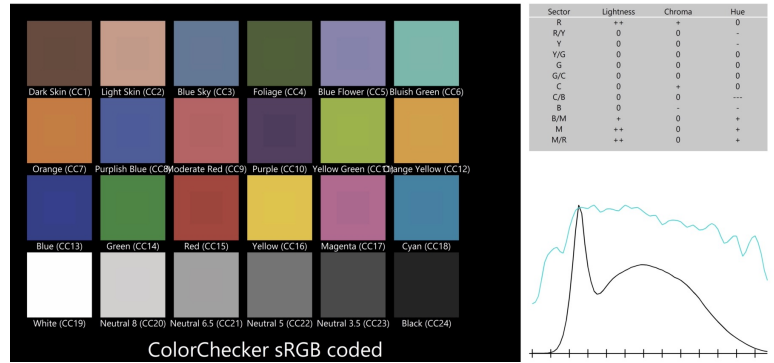

CQS - NIST Colour Quality Scale

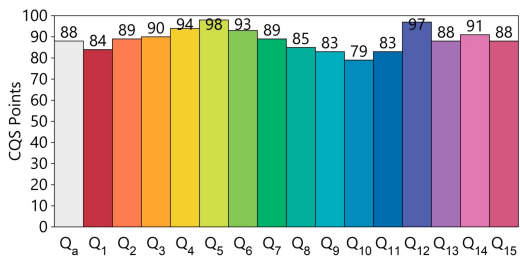

ANSI/IES TM-30-18 Colour Rendition Report

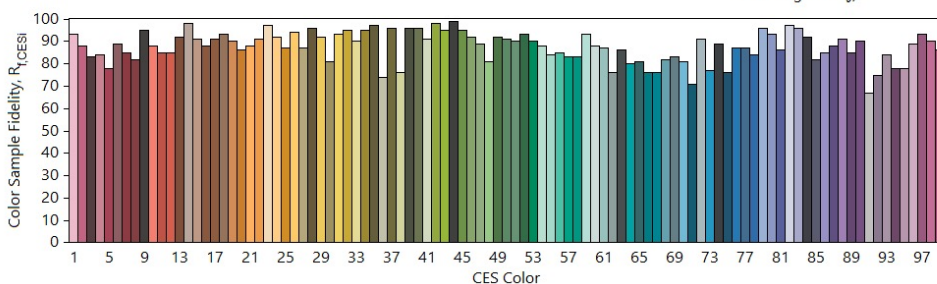
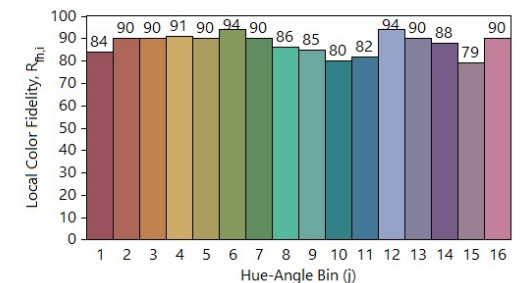
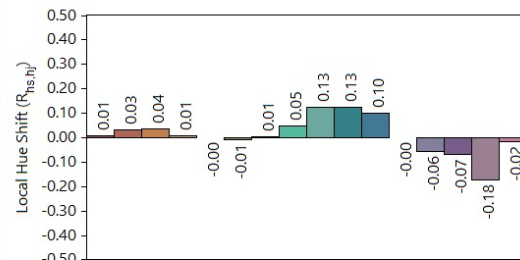
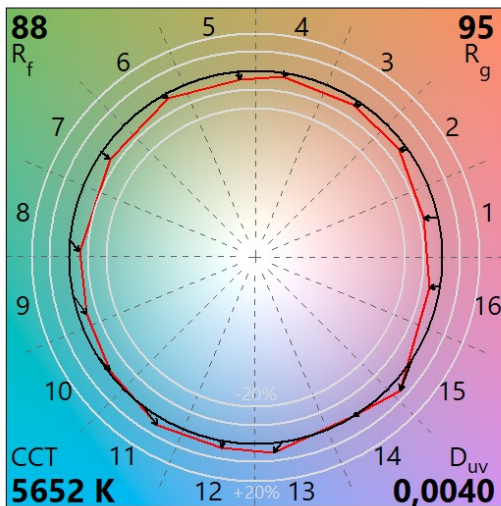
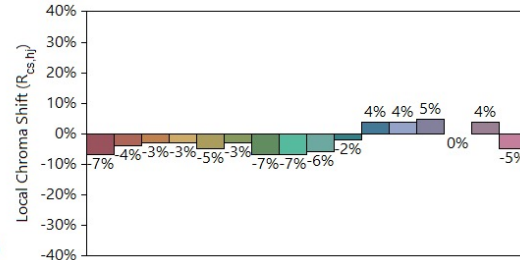
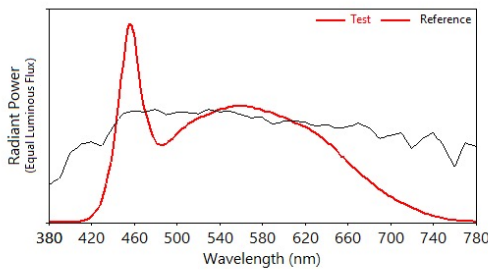

Colours are for visual orientation purposes only. Created with the IES TM-30-18 Calculator Version 2.00