

329HPB

329 - 2000/2500 W TUNGSTEN



- **Type:** Single lens luminaire
- **Source:** 2000/2500 W Tungsten
- **Optics:** 200 mm Pebble lens

Single lens

The industry standard for 2.5K units

329H is a favourite in theatres, opera houses and concert halls the world over.

A G22 lamp socket holds the lamp securely in place giving reliability, longer lamp life and 2000 W or 2500 W lamp options. Ideal for medium to large venues and rental companies.

Features

- **Theatre front cassette:** no light spill to distract audiences or performers
- **Colour runners:** double runners to hold accessories and colour filters
- **Barn door:** unique rotating barn door with 4 individually rotating blades – makes even the most difficult angle possible
- **Focus adjustment:** smooth focus adjustment from front or rear, even when lantern is hot, for a longer lamp life
- **Tilt reference on hanging yoke:** index for rapid re-positioning

Optical

- **G22 socket:** accepts 2000 W and 2500 W lamps
- **200 mm lens:** compact size 2 / 2.5 KW fixture

Construction

- **Made in France :** fully manufactured in Robert Juliat premises retaining complete control over all aspects of quality
- **Air vents:** efficient cooling with no light spill
- **Bodywork:** strong sheet metal construction for durability
- **Moving parts:** smooth at all times, even when hot
- **Captive knobs and handles:** additional security when working at height or in transit
- **Access:** easy access to lamp house and lenses through front opening for fast and efficient maintenance
- **Easy access to all parts:** easy cleaning, re-lamping and maintenance
- **Safety grid:** earthed safety grid fitted as standard
- **Safety first:** front accessories safety cable attachment point

Picture:329H

DSEN024_329HPB - 23/03/2022

Robert Juliat reserves the right to change or alter any of the items detailed on this page, to increase or improve manufacturing techniques without prior notice.

Robert Juliat S.A.S., 32 rue de Beaumont, 60530 Fresnoy-en-Thelle - France
Telephone : +33 (0)3 44 26 51 89 - fax : +33 (0)3 44 26 90 79 - info@robertjuliat.fr
www.robertjuliat.com



ROBERT JULIAT

Source



- **Lamp type:** Tungsten
- **Socket:** G22

Admissible lamps	Power *	Lumen output*	Colour temperature*	Life*
LIF: CP92	2 000 W	52 000 lm	3200K	400 h
LIF: CP91	2 500 W	65 000 lm	3200K	400 h

(*) manufacturer's data

Optics

Characteristics

- **Type:** Single lens
- **Beam range:** 9° to 68°
- **Lens:** 200 mm Pebble lens

Gel filter

- **Shape:** Square
- **Standard size:** 245x245 mm (9.6x9.6 in)

Photometrics

with LIF: CP91 source

• Optics @ 9°

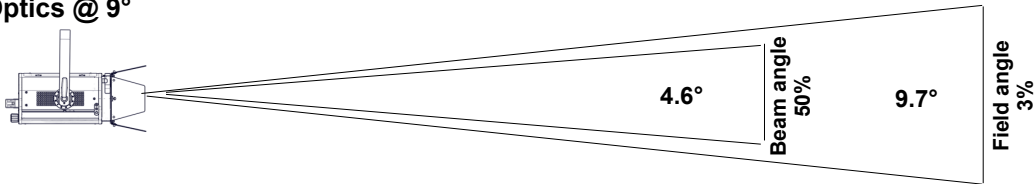

Beam intensity
535 000 cd

Distance	5 m	10 m	15 m	20 m	25 m	30 m
Diameter	0.8 m	1.7 m	2.5 m	3.4 m	4.2 m	5.1 m
Illumination	21 500 lux	5 400 lux	2 400 lux	1 350 lux	860 lux	600 lux
Distance	15 ft	35 ft	50 ft	65 ft	80 ft	100 ft
Diameter	2.5 ft	5.9 ft	8.5 ft	11 ft	13.6 ft	17 ft
Illumination	2 400 fc	440 fc	220 fc	130 fc	85 fc	55 fc

• Optics @ 68°

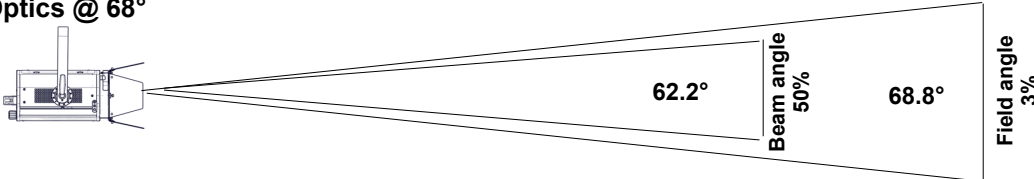

Beam intensity
24 000 cd

Distance	5 m	10 m	15 m	20 m	25 m	30 m
Diameter	6.8 m	13.7 m	20.5 m	27.4 m	34.2 m	41.1 m
Illumination	970 lux	250 lux	110 lux	65 lux	39 lux	27 lux
Distance	15 ft	35 ft	50 ft	65 ft	80 ft	100 ft
Diameter	20.5 ft	47.9 ft	68.5 ft	89 ft	109.6 ft	136.9 ft
Illumination	110 fc	20 fc	10 fc	6 fc	4 fc	3 fc

Dimensions and weight

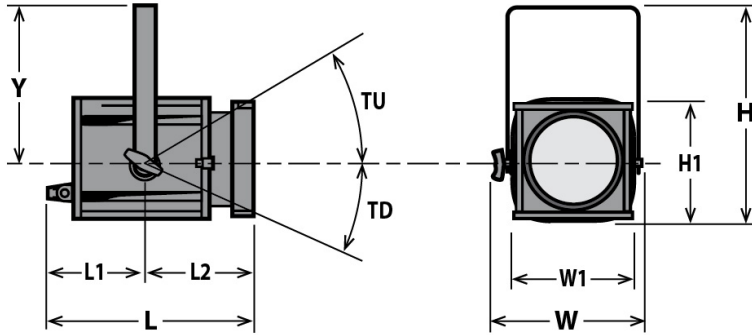

Weight: 14 kg (30.8 lbs)

Height	Length	Width	Yoke	Tilt
H= 520 mm (20.5 in)	L= 470 mm (18.5 in)	W= 410 mm (16.1 in)	Y= 345 mm (13.6 in)	TU= TBD°
H1= 320 mm (12.6 in)	L1= 285 mm (11.2 in) L2= 185 mm (7.3 in)	W1= 320 mm (12.6 in)		TD= TBD°

Shipping

- **Weight :** 16 kg (35.2 lbs)
- **Volume :** .09 m³ (3.18 ft³)

Installation

- **Minimum distance to illuminated surface:** 2.7 m (8.9 ft)
- **Operating position:**



Construction

- **Housing:** Steel sheet - Aluminium
- **Colour:** Black
- **Cooling:** Convection cooling
- **Maximum ambient temperature (Ta):** 40°C (104°F)
- **Maximum case temperature (Tc):** 250°C (482°F)
- **Total heat dissipation:** 6 826 BTU/h
- **Ingress Protection (IP) rating:** IP20

Electrical compatibility

- 230/240 V - 50 Hz
- ~~115/120 V - 60 Hz~~

Power input



- **Type:** attached power cord
- **Cable:** H07RNF 3G1.5
- **Length:** 3 m (9.8 ft)
- **Power connector:** CEE 7/7 (2P+E NF/Schuko)

Power consumption

Voltage	Frequency	Current	Power
230 V	50 Hz	9 A	2000 W
230 V	50 Hz	11 A	2500 W

Warranty

- **Fixture: 2 years**
See General Sales Condition on website

Approvals



Model

329HPB

2000/2500 W Tungsten Single lens luminaire - G22 socket - 200mm Pebble - 329HPB









Options

PCP1716A

16A blue 2P+E 6h IEC60309 power connector



Accessories

PF329M	245x245mm metal filter holder - Poids: 0.23 Kg 1 included	
G329	245x245mm safety grid 1 included	
CP91	CP91 - G22 2500W 230V 400h 3200K lamp	
CP92	CP92 - G22 2000W 230V 400h 3200K lamp	
CF329	4 rotating leaves on a rotating barndoor - 245x245mm (without safety cable) - Poids: 1.42 Kg	
876	Hook clamp 40x10mm with 28mm M10 screw for Ø35 to 50mm pipes - SWL: 50Kg - Poids: 1.25 Kg	
880	Hook clamp 40x10mm with 28mm M10 screw for Ø50 to 63mm pipes - SWL: 50Kg - Poids: 1.36 Kg	
CS2	Safety cable Ø3 mm L= 600mm - SWL: 75 Kg	
CS5	Safety cable Ø1,5 mm L=300mm for front accessory with karabiner and quick link - SWL: 25 Kg	