

SULLY - 305LPB CW

305 - LED 115 W



- **Type:** Single lens luminaire
- **Source:** LED 115 W
- **Optics:** 150 mm Pebble lens
- **Colour temperature:** Cool White

Single lens

The multi-purpose LED spot with interchangeable lens

Providing a multi-faceted solution in a compact package, Sully 305LPB luminaire combines a high-quality 115W white LED source with a single 150 mm / 6" Pebble Convex lens which can be easily changed for a Fresnel lens. It is especially valuable in multi-purpose venues and rental companies where the interchangeable lens can be put to full use. With uniform light, very wide beam spread up to 100° and premium colour rendering, Sully Pebble will easily substitute 1000W tungsten models. It is an affordable and lightweight unit with no compromise on build quality and overall performance.

Features

- **Theatre front cassette:** no light spill to distract audiences or performers
- **Colour runners:** double runners to hold accessories and colour filters
- **Barn door:** unique rotating barn door with 4 individually rotating blades – makes even the most difficult angle possible
- **Adjustable response time:** choice of fast or slow dimming for tungsten-like simulation - adjustment by DMX protocol
- **Universal data control:** compatible with DMX, RDM, Art-Net, sACN protocols
- **Remote setup:** all parameters can be adjusted by RDM protocol or by web interface
- **PWM adjustment:** choice of different PWM dimming frequencies - continuous mode available
- **DMX:** 8 or 16 bit dimming and strobe function
- **Dimming parameters:** choice of square or linear dimming curves
- **Local setup (optional):** DMX address and mode, dimming curve and response time through 4-button display with automatic light switch-off
- **Focus reference:** index for easy focus reference
- **Focus adjustment:** smooth focus adjustment from rear
- **Tilt reference on hanging yoke:** index for rapid re-positioning

Optical

- **Long life:** outstanding operational lifetime expectation, no need to replace lamps, low maintenance
- **Beam shaping :** efficient barndoors in any focus position
- **Wide angle:** up to 100° from edge to edge
- **Choice of 2 lenses :** Fresnel or Pebble-Convex lens – requires a standard screwdriver only
- **Narrow beam:** up to 10° with optional extender system
- **Electronic dimmer:** dimming without clipping or cut-out at low intensity levels; high quality smoothing
- **No colour shift:** colour temperature remains the same when dimming

Construction

- **Made in France :** fully manufactured in Robert Juliat premises retaining complete control over all aspects of quality
- **PSU:** built-in electronic flicker-free power supply for easy, plug-and-play installation
- **Power connectors:** neutriK® powerCON TRUE1 TOP IN and OUT connectors for daisy chaining
- **Silent-running cooling fans:** ideal for TV studios and opera houses
- **Electronic thermal management system:** ensures maximum performance of the system without any risk of overheating
- **Bodywork:** strong sheet metal construction for durability
- **Captive knobs and handles:** additional security when working at height or in transit
- **Easy access to all parts:** easy cleaning and maintenance
- **Safety first:** front accessories safety cable attachment point

Picture:305LPB

DSEN372_305LPB_CW - 23/03/2022

Robert Juliat reserves the right to change or alter any of the items detailed on this page, to increase or improve manufacturing techniques without prior notice.

Robert Juliat S.A.S., 32 rue de Beaumont, 60530 Fresnoy-en-Thelle - France
Telephone : +33 (0)3 44 26 51 89 - fax : +33 (0)3 44 26 90 79 - info@robertjuliat.fr
www.robertjuliat.com



ROBERT JULIAT

Source (Light quality report(s) available at the end of the document)



- **Lamp type:** LED
- **Power:** 115 W

LED specifications	Power *	Lumen output*	Colour temperature*	CRI*
LED 115W CW	115 W	14 300 lm	5700K	93

(*) manufacturer's data

Optics

Characteristics

- **Type:** Single lens
- **Beam range:** 28° to 100°
10° to 75° configuration possible
- **Lens:** 150 mm Pebble lens

Gel filter

- **Shape:** Square
- **Standard size:** 180x180 mm (7.1x7.1")

Photometrics (Photometrics report(s) available at the end of the document)

with LED 115W CW source

• Optics @ 28°

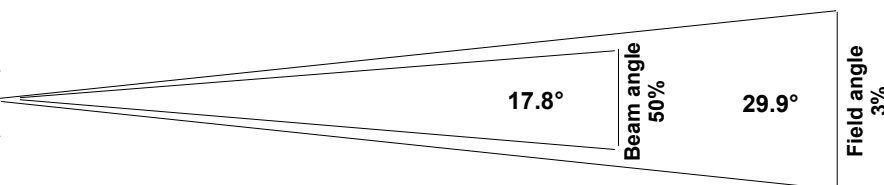
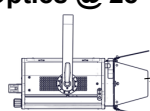

Beam intensity
22 400 cd

Field lumens
2 850 lm

Efficacy
22 lm/W

Distance	3 m	5 m	7 m	10 m	12 m	15 m
Diameter	1.6 m	2.7 m	3.7 m	5.3 m	6.4 m	8 m
Illumination	2 500 lux	900 lux	460 lux	230 lux	160 lux	100 lux
Distance	10 ft	15 ft	25 ft	35 ft	40 ft	50 ft
Diameter	5.3 ft	8 ft	13.4 ft	18.7 ft	21.4 ft	26.7 ft
Illumination	230 fc	100 fc	36 fc	19 fc	15 fc	9 fc

• Optics @ 100°

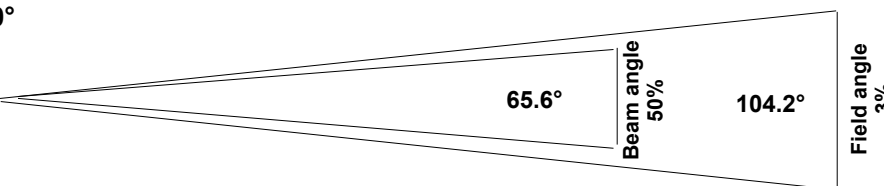
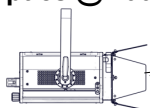

Beam intensity
5 600 cd

Field lumens
13 150 lm

Efficacy
102 lm/W

Distance	3 m	5 m	7 m	10 m	12 m	15 m
Diameter	7.7 m	12.8 m	18 m	25.7 m	30.8 m	38.5 m
Illumination	630 lux	230 lux	120 lux	60 lux	39 lux	25 lux
Distance	10 ft	15 ft	25 ft	35 ft	40 ft	50 ft
Diameter	25.7 ft	38.5 ft	64.2 ft	89.9 ft	102.8 ft	128.5 ft
Illumination	60 fc	25 fc	9 fc	5 fc	4 fc	3 fc

Remote control

- **Data protocol:** USITT DMX512-A
RDM / Art-Net / sACN

- **Data IN connector:** 5 pins XLR mâle + etherCON RJ45
- **Data OUT connector:** 5 pins XLR femelle



• DMX chart:

Mode 1 (1 channels)

Dimmer

Mode 2 (2 channels)

Dimmer
Dimmer fine

Mode 3 (5 channels)

Dimmer
Strobe duration
Strobe speed
Response time
Control mode

Mode 4 (6 channels)

Dimmer
Master dimmer
Strobe duration
Strobe speed
Response time
Control mode

Dimensions and weight

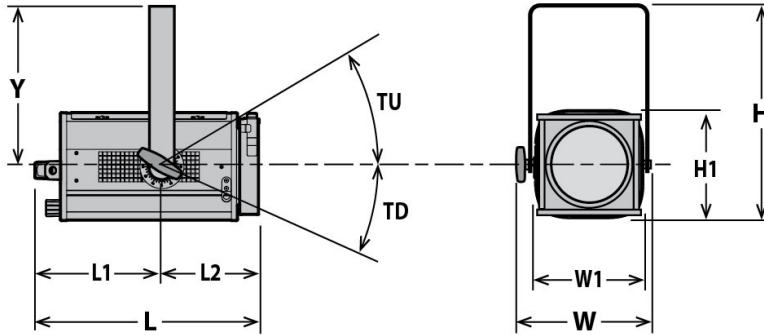

Weight: 9.5 kg (20.9 lbs)

Height	Length	Width	Yoke	Tilt
H= 387 mm (15.2 in)	L= 423 mm (16.7 in)	W= 304 mm (12 in)	Y= 283 mm (11.1 in)	TU= 90°
H1= 212 mm (8.3 in)	L1= 231 mm (9.1 in)	W1= 208 mm (8.2 in)		TD= 90°
	L2= 192 mm (7.6 in)			

Shipping

- **Weight :** 10.65 kg (23.4 lbs)
- **Volume :** .04 m³ (1.48 ft³)

Installation

- **Minimum distance to illuminated surface:** 0.2 m (0.7 ft)
- **Operating position:**



Construction

- **Housing:** Steel sheet - Aluminium
- **Colour:** Black
- **Cooling:** Low noise variable fan
- **Maximum ambient temperature (Ta):** 40°C (104°F)
- **Maximum case temperature (Tc):** 62°C (143.6°F)
- **Total heat dissipation:** 444 BTU/h
- **Ingress Protection (IP) rating:** IP20

Electrical compatibility

- 220/230 V - 50 Hz
- 245 V - 50 Hz
- 110/120 V - 60 Hz
- 208 V - 60 Hz
- 220/230 V - 60 Hz
- 100 V - 50 Hz
- 100 V - 60 Hz
- Selector: automatic detection

Power input



- **Type:** removable power cord with Neutrik powerCON TRUE1 TOP connector (included)
- **Cable:** H07RNF 3G1.5
- **Length:** 3 m (9.8 ft)
- **Power connector:** CEE 7/7 (2P+E NF/Schuko)

Power consumption

Voltage	Frequency	Current	Power	Power factor
230 V	50 Hz	0.7 A	130 W	0.81
120 V	60 Hz	1.15 A	135 W	0.98
100 V	60 Hz	1.4 A	135 W	0.96

Power Supply Unit

- **PSU:** Internal - Electronic PSU - Flicker free with PFC
- **Control:** / DMX
- **Protection:** Mains: 2x 6.3A 5x20 T fuses /
- **Power thru:** Neutrik powerCON TRUE1 TOP - Maximum of 22 units (230 V) / 12 units (120 V)

Warranty

- **Fixture: 3 years**
See General Sales Condition on website

Approvals



Acoustics

- **Noise level:** < 24 dB(A)







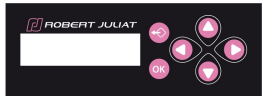

Model

305LPB CW	LED 115 W Single lens luminaire - 150mm Pebble - 305LPB CW Sully - Cool White
------------------	---

Options

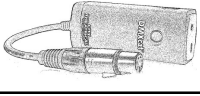
PCP1716A	16A blue 2P+E 6h IEC60309 power connector	
DISP1	Display and keyboard for local setup	

Accessories

PF500M2	180x180mm metal filter holder 1 included	
CF500	4 rotating leaves on a rotating barndoor - 180x180mm (without safety cable) - Poids: 0.82 Kg	
L150 F/2	Ø150mm Fresnel lens with double slot front cassette for 180x180mm accessories - Poids: 0.8 Kg	
ROPT1	Narrow beam extender for 305LPB - Poids: 0.5 Kg	
TH600	180x180mm "Top hat" (without safety cable) - ø150mm / 150mm long	
DMXcat	Bluetooth DMX/RDM Multifunction test tool - City Theatrical DMXcat®	
876	Hook clamp 40x10mm with 28mm M10 screw for Ø35 to 50mm pipes - SWL: 50Kg - Poids: 1.25 Kg	
880	Hook clamp 40x10mm with 28mm M10 screw for Ø50 to 63mm pipes - SWL: 50Kg - Poids: 1.36 Kg	
CS2	Safety cable Ø3 mm L= 600mm - SWL: 75 Kg	
CS5	Safety cable Ø1,5 mm L=300mm for front accessory with karabiner and quick link - SWL: 25 Kg	

• Optics @ 28°

Field lumens	Beam lumens	Efficacy	Beam intensity	CCT	Delta uv
2 850 Lm		22 Lm/W	22 400 Cd	5 380 K	

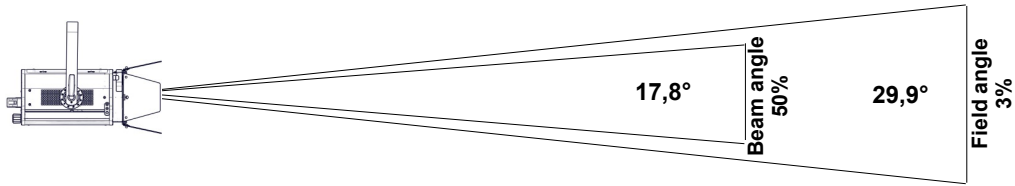

Distance	3 m	5 m	7 m	10 m	12 m	15 m
Field diameter	1,6 m	2,7 m	3,7 m	5,3 m	6,4 m	8 m
Illumination	2 500 lux	900 lux	460 lux	230 lux	160 lux	100 lux
Distance	10 ft	15 ft	25 ft	35 ft	40 ft	50 ft
Field diameter	5,3 ft	8 ft	13,4 ft	18,7 ft	21,4 ft	26,7 ft
Illumination	230 fc	100 fc	36 fc	19 fc	15 fc	9 fc

• Optics @ 60°

Field lumens	Beam lumens	Efficacy	Beam intensity	CCT	Delta uv
7 200 Lm		56 Lm/W	9 900 Cd	5 340 K	

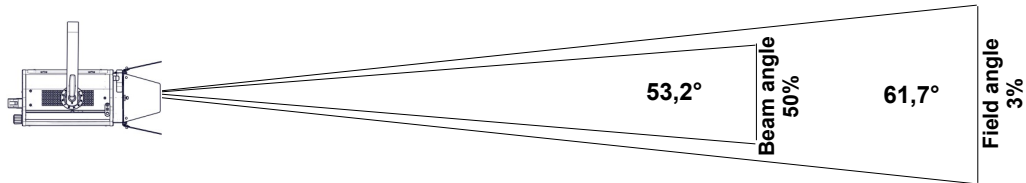

Distance	3 m	5 m	7 m	10 m	12 m	15 m
Field diameter	3,6 m	6 m	8,4 m	11,9 m	14,3 m	17,9 m
Illumination	1 150 lux	400 lux	210 lux	100 lux	70 lux	45 lux
Distance	10 ft	15 ft	25 ft	35 ft	40 ft	50 ft
Field diameter	11,9 ft	17,9 ft	29,9 ft	41,8 ft	47,8 ft	59,7 ft
Illumination	100 fc	45 fc	16 fc	9 fc	7 fc	4 fc

• Optics @ 100°

Field lumens	Beam lumens	Efficacy	Beam intensity	CCT	Delta uv
13 150 Lm		102 Lm/W	5 600 Cd	5 420 K	

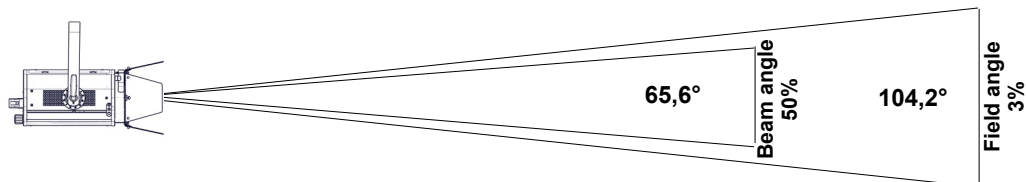

Distance	3 m	5 m	7 m	10 m	12 m	15 m
Field diameter	7,7 m	12,8 m	18 m	25,7 m	30,8 m	38,5 m
Illumination	630 lux	230 lux	120 lux	60 lux	39 lux	25 lux
Distance	10 ft	15 ft	25 ft	35 ft	40 ft	50 ft
Field diameter	25,7 ft	38,5 ft	64,2 ft	89,9 ft	102,8 ft	128,5 ft
Illumination	60 fc	25 fc	9 fc	5 fc	4 fc	3 fc

• Optics @ 10°

Field lumens	Beam lumens	Efficacy	Beam intensity	CCT	Delta uv
1 360 Lm		11 Lm/W	135 900 Cd	5 470 K	

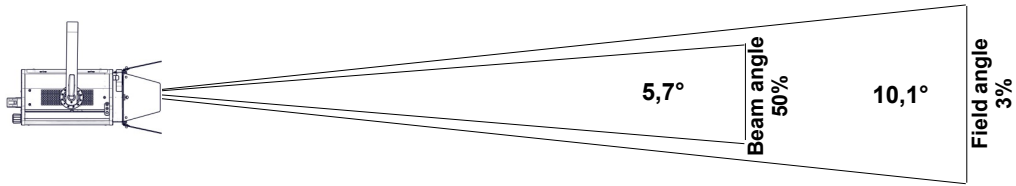

Distance	3 m	5 m	7 m	10 m	12 m	15 m
Field diameter	0,5 m	0,9 m	1,2 m	1,8 m	2,1 m	2,7 m
Illumination	15 500 lux	5 500 lux	2 800 lux	1 400 lux	950 lux	610 lux
Distance	10 ft	15 ft	25 ft	35 ft	40 ft	50 ft
Field diameter	1,8 ft	2,7 ft	4,4 ft	6,2 ft	7,1 ft	8,8 ft
Illumination	1 400 fc	610 fc	220 fc	120 fc	85 fc	55 fc

• Optics @ 30°

Field lumens	Beam lumens	Efficacy	Beam intensity	CCT	Delta uv
3 200 Lm		25 Lm/W	26 200 Cd	5 580 K	

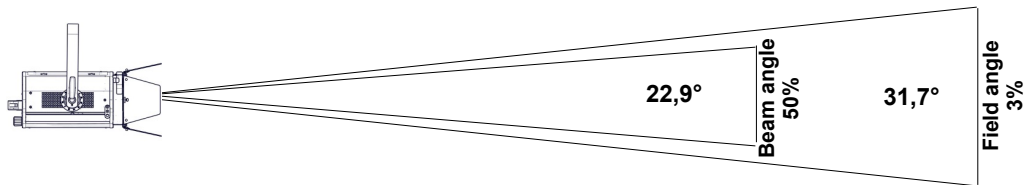

Distance	3 m	5 m	7 m	10 m	12 m	15 m
Field diameter	1,7 m	2,8 m	4 m	5,7 m	6,8 m	8,5 m
Illumination	2 950 lux	1 050 lux	540 lux	270 lux	190 lux	120 lux
Distance	10 ft	15 ft	25 ft	35 ft	40 ft	50 ft
Field diameter	5,7 ft	8,5 ft	14,2 ft	19,9 ft	22,7 ft	28,4 ft
Illumination	270 fc	120 fc	42 fc	22 fc	17 fc	11 fc

• Optics @ 75°

Field lumens	Beam lumens	Efficacy	Beam intensity	CCT	Delta uv
8 300 Lm		64 Lm/W	7 500 Cd	5 550 K	

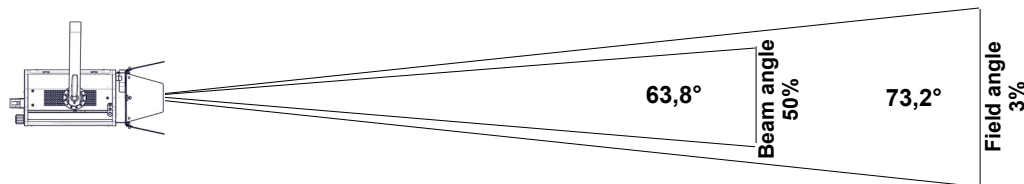

Distance	3 m	5 m	7 m	10 m	12 m	15 m
Field diameter	4,5 m	7,4 m	10,4 m	14,9 m	17,8 m	22,3 m
Illumination	840 lux	310 lux	160 lux	80 lux	55 lux	34 lux
Distance	10 ft	15 ft	25 ft	35 ft	40 ft	50 ft
Field diameter	14,9 ft	22,3 ft	37,1 ft	52 ft	59,4 ft	74,3 ft
Illumination	80 fc	34 fc	13 fc	7 fc	5 fc	4 fc

Light quality report

CCT	DeltaUV	CRI Ra	CRI R9	CQS Qa	TM30-18 Rf	TM30-18 Rg	TLCI	SSI [D5712]
5 710K	0.0011	94	67	93	92	103	90	70

CRI - CIE Colour Rendering Index

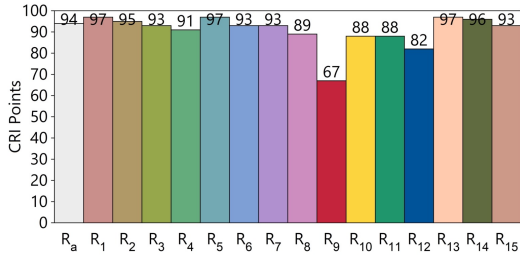

TLCI - Television Lighting Consistency Index

Test : CCT = D5711 (-0.4)
 TLCI-2012 : 90 (D5711)

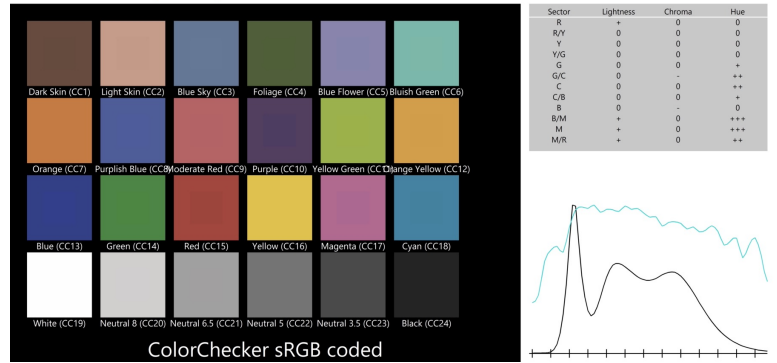

CQS - NIST Colour Quality Scale

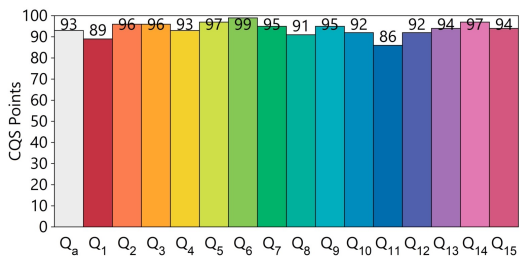

ANSI/IES TM-30-18 Colour Rendition Report

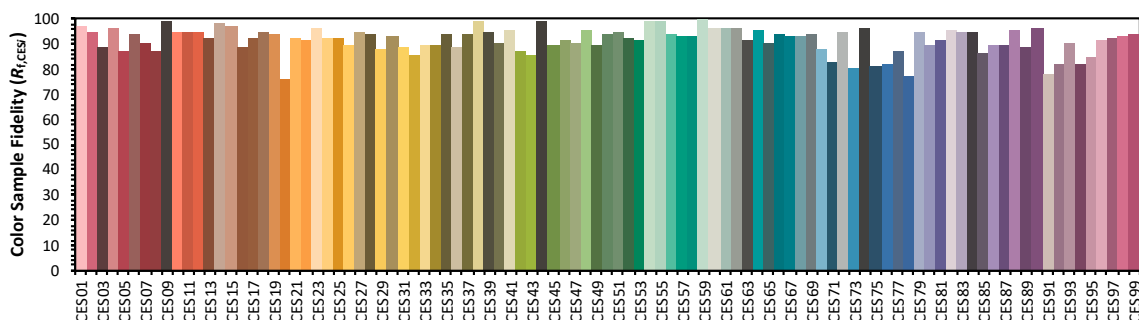
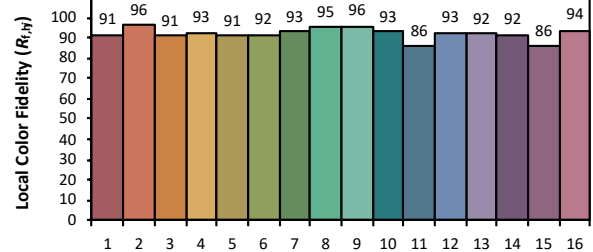
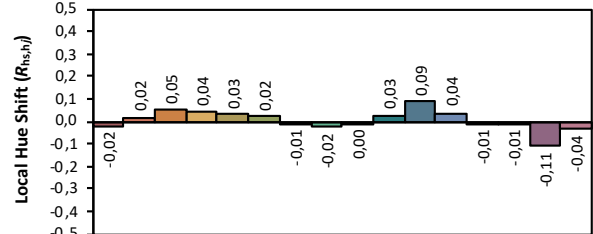
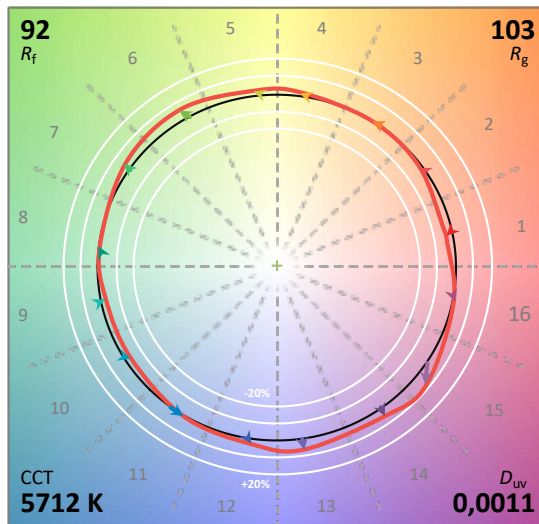
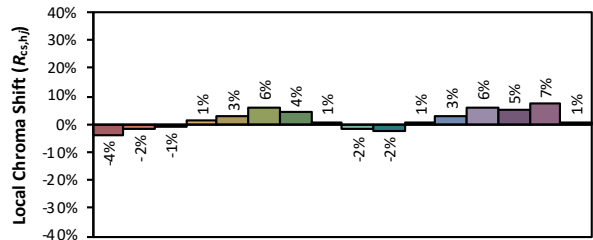
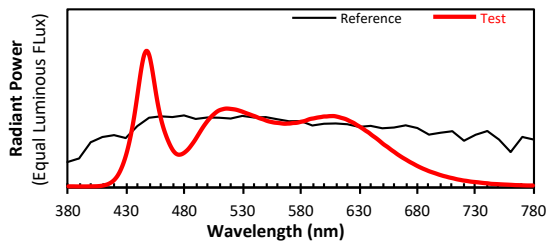

Colours are for visual orientation purposes only. Created with the IES TM-30-18 Calculator Version 2.00